



Keck Adaptive Optics Note 714

**Keck Next Generation Adaptive Optics:
AO Control System Design Document**

Doug Morrison, Kevin Tsubota
March 3, 2010



Revision History

Revision	Date	Author(s)	Remarks
1.0		Douglas Morrison Kevin Tsubota	Initial release.



Table of Contents

1	Introduction	5
2	Glossary	5
3	Document Overview	6
3.1	Subsystem Template	6
3.1.1	Description	6
3.1.2	Interfaces	6
3.1.3	Control Loops	7
3.1.4	Devices	7
4	Controls Infrastructure	8
4.1	Framework	8
4.2	Common Services	9
4.2.1	Connection Service	10
4.2.2	Event Service	10
4.2.3	Health Monitoring	11
4.2.4	Logging	11
4.2.5	Archiving	12
4.2.6	Alarming	12
4.2.7	Configuration	12
4.3	Component Architecture	12
4.3.1	Controllers	12
4.3.2	Composites	12
4.3.3	Sequencing	12
4.3.4	Device Control Interface	12
4.4	Low Level Motion Device Control	14
4.4.1	Discrete Commanded Devices	16
4.4.2	Non-tracking Devices	16
4.4.3	Tracking Devices	17
4.5	Low Level Non-Motion Device Control	18
4.5.1	Remote Power Control	20
4.5.2	Camera / Detector Control	20
4.5.3	Discrete (Digital) Input/Output	20
4.5.4	Analog Input	20
4.5.5	Analog Output	21
4.5.6	COTS Controllers	21
4.5.7	Remote Reset control	21
4.5.8	Video	21
4.5.9	RS-232 and USB	21
4.5.10	Ethernet	21
4.5.11	Time Distribution / Synchronization	21
5	AO System	22
5.1	Introduction	22
5.2	Low Order Relay	23
5.2.1	Description	23
5.2.2	Interfaces	23
5.2.3	Control Loops	23
5.2.4	Devices	23
5.3	Acquisition System	25
5.3.1	Description	25
5.3.2	Interfaces	25
5.3.3	Control Loops	25



5.3.4	<i>Devices</i>	25
5.4	LGS Wavefront Sensors	26
5.4.1	<i>Description</i>	26
5.4.2	<i>Interfaces</i>	27
5.4.3	<i>Control Loops</i>	28
5.4.4	<i>Devices</i>	30
5.5	Low Order Wavefront Sensors	32
5.5.1	<i>Description</i>	32
5.5.2	<i>Interfaces</i>	33
5.5.3	<i>Control Loops</i>	34
5.5.4	<i>Devices</i>	34
5.6	High Order Relay	36
5.6.1	<i>Description</i>	36
5.6.2	<i>Interfaces</i>	36
5.6.3	<i>Control Loops</i>	37
5.6.4	<i>Devices</i>	37
5.7	NGS Wavefront Sensor	38
5.7.1	<i>Description</i>	38
5.7.2	<i>Interfaces</i>	38
5.7.3	<i>Control Loops</i>	40
5.7.4	<i>Devices</i>	40
5.8	Atmospheric Dispersion Corrector	42
5.8.1	<i>Description</i>	42
5.8.2	<i>Interfaces</i>	42
5.8.3	<i>Control Loops</i>	42
5.8.4	<i>Devices</i>	42
5.9	RTC Interface	44
5.9.1	<i>Description</i>	44
5.9.2	<i>Interfaces</i>	44
5.9.3	<i>Control Loops</i>	44
5.9.4	<i>Devices</i>	44
5.10	External Offloading	45
5.10.2	<i>Description</i>	45
5.10.3	<i>Interfaces</i>	46
5.10.4	<i>Control Loops</i>	46
5.10.5	<i>Devices</i>	46
5.11	Calibration Simulation	47
5.11.1	<i>Description</i>	47
5.11.2	<i>Interfaces</i>	47
5.11.3	<i>Control Loops</i>	47
5.11.4	<i>Devices</i>	47
5.12	AO Enclosures	48
5.12.1	<i>Description</i>	48
5.12.2	<i>Interfaces</i>	48
5.12.3	<i>Control Loops</i>	48
5.12.4	<i>Devices</i>	48
5.13	AO Control Sequencer	49
5.13.1	<i>Description</i>	49
5.13.2	<i>Interfaces</i>	49
5.13.3	<i>Control Loops</i>	49
5.13.4	<i>Devices</i>	49
6	Laser System	50
6.1	Introduction	50
6.2	Laser Switchyard	50



6.2.1	Description	50
6.2.2	Interfaces	51
6.2.3	Control Loops	53
6.2.4	Devices	54
6.3	Laser Beam Generation System	56
6.3.1	Description	56
6.3.2	Interfaces	57
6.3.3	Control Loops	59
6.3.4	Devices	60
6.4	Laser Safety System.....	62
6.4.1	Description	62
6.4.2	Interfaces	62
6.4.3	Control Loops	64
6.4.4	Devices	64
6.5	Laser Service Enclosure.....	65
6.5.1	Description	65
6.5.2	Interfaces	65
6.5.3	Control Loops	66
6.5.4	Devices	66
6.6	Laser Interface	67
6.6.1	Description	67
6.6.2	Interfaces	67
6.6.3	Control Loops	69
6.6.4	Devices	69
6.7	Laser Control Sequencer.....	70
6.7.1	Description	70
6.7.2	Interfaces	70
6.7.3	Control Loops	72
6.7.4	Devices	73
7	Data Server.....	73
8	Risk Analysis.....	74
9	Issues Requiring Resolution During DD Phase	75
A1.	Functional Requirements.....	76

1 Introduction

This document describes the system design for the Non-Real-Time Controls portion of the NGAO system for the Preliminary Design Phase.

We begin by discussing the overall distributed controls architecture for the AO system, followed by each subsystem level software component design.

2 Glossary

The following terms and acronyms will be used throughout this document:

Acronym	Definition
BGS	Beam Generation System
DM	Deformable Mirror
IFS	Integral Field Spectrograph
KAON	Keck Adaptive Optics Note
KCSF	Keck Common Service Framework



LGS	Laser Guide Star
LOWFS	Low Order Wavefront Sensor
LLT	Laser Launch Telescope
LSS	Laser Safety System
LTO	Laser Transport Optics
MSCS	Multi-System Command Sequencer
NGAO	Next Generation Adaptive Optics
NGS	Natural Guide Star
OA	Observing Assistant
OOCD	Observing Operations Concept Document
PNS	Point-and-Shoot
PSF	Point Spread Function
TT	Tip-Tilt
TTFA	Tip-Tilt Focus and Astigmatism (LOWFS)
TWFS	Truth Wavefront Sensor
VA	Vertical Angle
WFS	Wavefront Sensor

3 Document Overview

3.1 Subsystem Template

Each subsystem of the NGAO controls architecture will be described in detail, and follow a consistent template as described here.

3.1.1 Description

An overview of each subsystem is given by describing its responsibilities, component composition and external collaborators.

3.1.2 Interfaces

The *Interfaces* section details the mechanisms provided by the subsystem for input and output with external components.

3.1.2.1 Inputs

The primary mechanism for commanding and interfacing with a subsystem is provided through the KCSF command interface. Methods are available to get and set attributes, execute commands, and monitor changes in component state. This section details all of the available actions recognized by the subsystem.

3.1.2.2 Outputs

NGAO subsystems will provide status and device information in the form of KCSF events. Any KCSF component can subscribe to a subsystem's published events. This section details each of the subsystem's event streams.



3.1.3 Control Loops

A subsystem or component may implement asynchronous background control tasks. These tasks could be responsible for device tracking, error offloading, and health monitoring. This section details all of the background tasks that will be performed by the subsystem and its controllers.

3.1.4 Devices

A subsystem is a logical organization of a set of hardware devices and their associated software controllers. This section will detail each of the devices managed by the subsystem and how they are used to satisfy the observing use-cases and requirements.



4 Controls Infrastructure

The entire NGAO system can be viewed as a distributed controls system, in which many different components communicate with each other in various client/server or master/slave relationships using possibly several communication networks and protocols. We have represented a high-level abstraction of the NGAO system in the block diagram shown below in Figure 1.

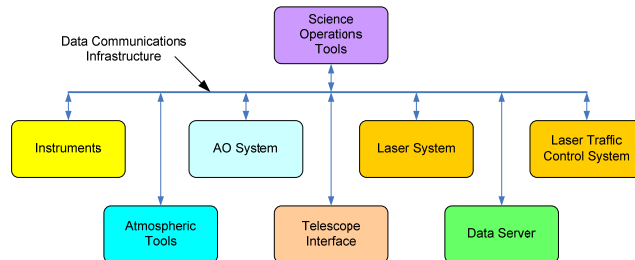

Figure 1 A Block diagram of the NGAO system viewed abstractly as a distributed controls system

Each block in the diagram represents a set of control functions peculiar to a particular system or subsystem that can logically be grouped together. The grouping is an abstraction, as the various functions represented by each block may actually be implemented using multiple software and hardware components that are also distributed. As of this writing, the primary data communications paradigm used by the NGAO system components has not been specified. We are assuming that it will be the keyword system already employed at the observatory, but this assumption should be revisited during the PD phase of the project.

This document describes the following three subsystems shown above in greater detail:

- AO System
- Laser System
- Data Server

4.1 Framework

We have chosen to use a Component-Based Development (CBD) model. This model focuses on removing dependencies between objects by designing components with strict and well defined interfaces. Components must conform to a known standard based on the problem each implementation is to solve. The goal is to be able to isolate the functional implementation of a task within a single plug-and-play object that can be modified or swapped with an alternative implementation without impacting the rest of the system. A user should be able to replace a component that satisfies a similar use-case without creating or breaking any dependencies in the system. Refer to [KAON 671](#) for more details.

Supporting the component based model will be a data communications infrastructure that is adopted from the Advance Technology Solar Telescope's (ATST) Common Services Framework (CSF). The benefits of a common services model for infrastructure include:

- All major system services are provided through standard interfaces used by all software packages.
- The separation of the functional and technical architectures provided by the common services model allows for a significant amount of the technical architecture to be provided through the common services, freeing up developers to concentrate on providing the functional behavior required of their software.



- Uniform implementation of the technical architecture across all systems allow implementation of the technical architecture to be upgraded with minimal impact on the development team or changes to the function software.
- Since application deployment is a technical issue and hence implemented within the common services, the software system as a whole is more easily managed within a distributed environment..

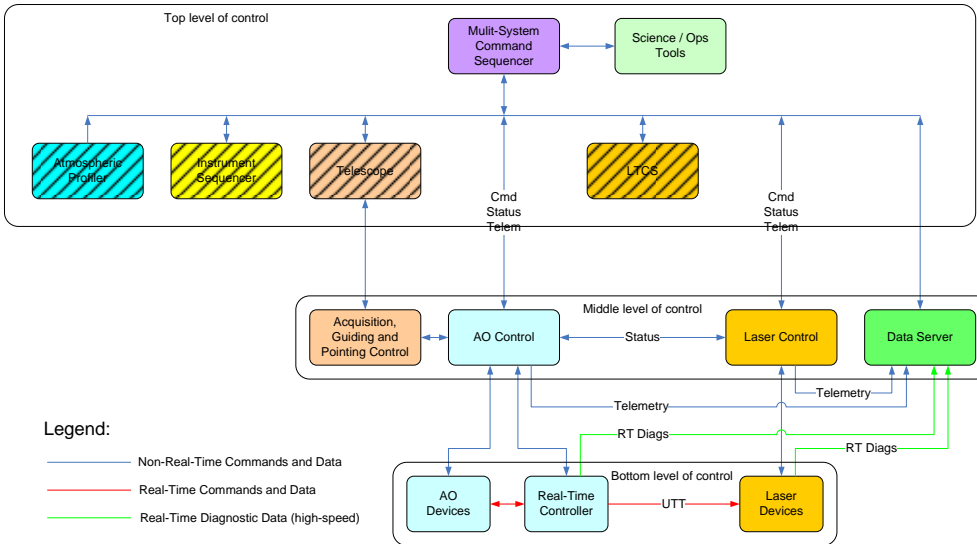

Figure 2 A block diagram of the AO controls infrastructure

The control systems are represented by a hierarchy in this diagram. At the top level are the main interfaces to the various subsystems (some of these interfaces are referred to as sequences in the diagram). All user commands to the subsystems pass through these top level interfaces. The middle level of the hierarchy represents an abstraction of more complex lower level control tasks, namely the basic control functions for that subsystem. Users do not access the system at this level except for engineering or troubleshooting purposes. Finally, at the bottom level of the hierarchy are the devices controlled by the control system themselves.

4.2 Common Services

Common services are infrastructure utilities that provide a black box implementation of typical, repetitive, or convenient functionality need by a software system. KCSF Common services are the backbone of controls architecture, and provide an abstract layer between the controls system and the underlying middleware infrastructure. As a distributed architecture, KCSF offers services to find and connect to remote processes, communicate between individual components in a system, and interface with other system outside of the KCSF infrastructure. Additional services are provided to manage software configurations; monitor the health and status of the system; respond to alarms; and archive system data and events.

The following sections give an overview of the KCSF common services. Additional details can be found in the *Common Services* section of KAON 679: NGAO Software Architecture. Any NGAO specific functionality or considerations related to the use of the common service will be discussed here.



4.2.1 Connection Service

KCSF provides a utility to find and create peer-to-peer connections to remote components in a distributed system through the Connection Service. This service is implemented as a black box to hide the details of the underlying middleware infrastructure, and provide an abstract, simple interface to clients. The following functionality is provided by the Connection Service:

- Register – A distributed component is associated with a unique name and is made public to the distributed control system. Once registered other components can find this object across the network by its unique name.
- Remove – An object is removed from the registry. The object name is no longer a valid endpoint on the network.
- Connect – Allows a component to find and connect to other components in the system based on their unique registered names. This creates a direct peer-to-peer connection through a proxy interface.
- Disconnect – A peer-to-peer connection with a remote component is terminated. The proxy interface no longer has a reference to the remote client.

The registration and removal process are handled automatically by the KCSF middleware: developers do not need to explicitly perform these tasks in their code. A component developer only needs to be concerned with opening and closing connections to distributed components to perform the functions of the controls system.

NGAO will not require any special implementation or any additional functionality that is not currently available with the standard KCSF Connection Service.

4.2.2 Event Service

The majority of broadcast and non-command messaging is satisfied using events. Events are based upon the publish-subscribe design pattern, and allow a component to make information available to the entire distributed system without requiring an explicit connection between clients. Events are designed to provide fast peer-less communication channels using the capabilities of the underlying middleware. KCSF provides access to the event system through the Event Service.

The KCSF Event Service has the following properties:

- An event stream (a.k.a *topic*) represents a many-to-many mapping: events may be posted to the topic from more than one source and received by zero or more targets. Typically, however, most event topics will have a single source.
- Events posted by a single source into an event topic are received by all targets in the same order as they were posted.
- Delivery of events to one subscriber cannot be blocked by the actions of another subscriber.
- Events are not queued by the service. A "late" subscriber will not see earlier events.
- The event service does not drop events. A published event will be delivered to all subscribers.
- Event topics are identified by a unique name.
- The Event Service supports arbitrary topic names.
- Events are automatically tagged with the source and a timestamp.

The Event Service provides a simple API to interface with event topics:

- Subscribe – Start listening to events published on a particular topic.
- Unsubscribe – Stop listening to events on a particular topic.
- Post – Publish data to a topic.

Events are received by a component by attaching a callback to a subscription. The event service, upon receipt of an event, invokes this callback in a separate thread. All events received from the same



subscription use the same thread: delivery order is preserved within the callback processing. If events are received faster than the callback can process them, the unprocessed events are locally queued within the event service. This is a potential problem, but represents a trade-off of mutually exclusive goals. Component developers are encouraged to write callbacks that process quickly. Numerous approaches are available to handle the case where the required action cannot be performed quickly - the best approach to use is dependent upon the nature of the specific task and is thus the responsibility of the component developer.

4.2.3 Health Monitoring

The ability to quickly ascertain device health throughout the NGAO control system is very important. KCSF supports this by providing a health monitoring service. The health of each component is monitored by its parent container. The various health states for a component are: good, ill, bad, and unknown, and are defined as follows (in order of worsening health):

- Good: No problems have been detected by the component, it is fully operational.
- Ill: Problems have been detected, but they do not prevent observing. Data quality, however, may be affected. It may also be the case that operation of the component will fail soon if corrective action is not taken. The component is partially operational.
- Bad: Severe problems have been detected. The component is unable to operate correctly. Corrective action is required.
- Unknown: The component is not responding. It may or may not be operating. This health value is not set by the component (obviously) but may be set by the health service.

The health service automatically posts an event showing changes to the component health and logs a warning on worsening health and a note on improving health. When a health condition worsens to bad or unknown the log message severity switches from warning to severe.

All components define an abstract *performCheckHealth* method, which must be implemented by the component developer. This method is responsible for determining the health of the component and returning its health status. For most NGAO controllers the health status will be based on feedback from the device or motion controller, and will typically be in either a *good* or *bad* state. Higher level composite components and sequencers will have to calculate health based on the overall status of their individual controllers. For these components determining health will be based on the importance of specific devices over others in the control system, where many failure scenarios can be categorized as either *bad* or *ill*.

4.2.4 Logging

Logging is the capability of writing messages to create a record of system events. Typically the content of a log message isn't intended for immediate review or action, and is instead intended to trace the execution of tasks and provide feedback of system performance. Log messages can typically be written to a variety of output streams for temporary viewing or long-term preservation. KCSF provides logging functionality through the Log Service.

The Log Service offers clients the ability to write messages to one of three types of outputs: console, file, and database. A log message is categorized by a specific log level, indicating the type of message and its importance. The KCSF Log Service defines a total of seven log levels ranging from a simple trace message to an emergency system event. When a message is issued the Log Service will automatically append timestamp and source information and format the message for consistency. The Log Service provides convenience methods for each of the defined log levels to simplify component development. The KCSF Log Service is described in detail in KAON 673: NGAO Software Architecture: Logging Service.

In addition to the Log Service, KCSF also provides a graphical log viewer. This tool allows users to inspect persistent log files saved to a database. Logs can be searched by specifying a range of options, including



date, log levels and sources. All log events that fit the search options will be displayed in a simple table organized by date-time, level and source.

The KCSF Log Service and viewer will be used unchanged for NGAO.

4.2.5 Archiving

4.2.6 Alarming

Alarms are reports of component failure (software or hardware) or other abnormal behavior within the system. Alarms occur asynchronously in a random fashion. Some alarm conditions may clear themselves and others may require operator intervention. The KCSF Alarm Service provides capabilities for components to set and clear alarms, and provides a managing system to detect the occurrence of alarms and initiate the appropriate system response. The Alarm Service is part of the larger NGAO alarm system.

The Alarm System is described in detail in KAON 677: NGAO Software Architecture: Alarm System

4.2.7 Configuration

4.3 Component Architecture

4.3.1 Controllers

4.3.2 Composites

4.3.3 Sequencing

4.3.4 Device Control Interface

The following section details the common input and output interfaces available to most NGAO components. In the AO and Laser system portions of this document the individual subsystem interfaces are detailed. Each subsystem will expand on these interfaces and include any device specific functionality involved in processing these actions and events. Subsystem may implement additional interface capabilities or omit specific functionality entirely. See each subsystem for more information.

4.3.4.1 Inputs

Home

The *Home* action is responsible for homing the component's related hardware devices. Typically this action is only applicable for motion control devices, and involves slewing to one or more limits and zeroing the



encoder position. Additional tasks may include configuring internal control loops, loading configuration files, and refreshing driver connections.

Initialize

The *Initialize* action is responsible for initializing a component and its related hardware devices. Software initialization consists of refreshing proxy connections, connecting to event stream, and clearing existing monitoring callbacks. Essentially the initialize action should return the software component to its starting configuration.

Hardware initializations cover motion control and static devices. As static devices, such as sensors, do not have any moving components an initialization usually performs a device refresh or some form of internal configuration (and may be similar to the *Home* action.) Motion control initializations, in addition to performing any required internal reconfigurations, will typically involve slewing to a known limit and returning to the home switch or a specific encoder position (e.g. zero). The initialization process for a device should be faster than homing, and must not invalidate its position counter. This allows an operator to accurately return an initialized device to a previously defined position.

SetMode

The *SetMode* action is responsible for configuring a component for a particular observing configuration. Every component in the NGAO control system is designed to recognize and understand its role in a particular observing mode, and will configure itself appropriately. The configuration process can include slewing devices, configuring device properties, making connections to remote components, disabling device controller, and powering down hardware. On completion of a *SetMode* action the component and its devices should be ready for observing in the desired mode.

Slew

The *Slew* action is common to all motion control devices and is responsible for commanding the device to a specified position. The specific format of the data is dependent on the type of device (tip-tilt, linear stage, etc.) and the number of degrees of freedom. Most controllers also permit the use of named positions allowing clients to specify an enumerated value in place of device counts or physical positions. On completion of the *Slew* command the controllers associated devices should reach their commanded position.

Track

The *Track* action is available to all motion control tracking devices. A tracking device is any device that runs in an event driven (or periodic) mode based on system events -- also known as closed loop motion control. The *Track* action commands the component and associated hardware to enter closed loop control to respond to one or more stimuli. For example, a focus stage that responds to focusing errors measured by a sensor. A component in track mode will stay in track until it receives a command to *Halt* or a problem is encountered.

Acquire

The *Acquire* action is a high-level operation available to composites and subsystems. This action is responsible for implementing the component and device sequence to acquire an observing target(s) (e.g. a tip-tilt NGS). Typically this action accepts target coordinates and properties that are used to calculate device positions, loop rates, and other system configurations. Depending on the responsibilities of the subsystem an acquire may cause devices to slew, sensors to reconfigure and control loops to close. On completion of this action the subsystem should be properly configured for observing.

Halt

The *Halt* action is available to all NGAO components and is designed to immediately open all tracking / offloading loops and cut power to all devices managed by the component. This action is executed to terminate a sequence -- either in response to a system failure or the end of an observation. The *Halt* action should leave all devices and components in a useable state: they should not require an initialization or



special recovery sequence; although the acquisition sequence may not be restarted before observing can continue.

Recover

The *Recover* action is available to all NGAO components, and is used in the context of selective initialization of one or more devices during a system fault. During observing, devices may encounter problems that cause the hardware motion controller and NGAO component to enter their FAULT state. Rather than being forced to terminate the observing sequence to resolve the problem, it may be desirable to continue observing, although in a potentially degraded capacity. In such an event the operator will be able to issue the *recover* action at the subsystem level.

When a *recover* is issued to a subsystem it is propagated to all of its child components, even if they report that they are functioning properly. Essentially the recover action is sent blindly to the entire control subsystem hierarchy. As each component receives the recover action it will check to see if it is currently in a faulted state. If it is, an initialization is performed to attempt to clear the fault, and if successful, the device is repositioned and loops are closed to bring the device(s) back into the proper operating state. (Note: device acquisition is only performed if the device had faulted while in the TRACK state.)

If the device can not be recovered it will remain in its faulted state, and direct operator intervention may be required at the device level. If a device fault is cleared at the device level (e.g. through an engineering GUI), the control system will still need to be told to recover from the fault by issuing the recover action: a component will not clear its fault just because the device reports “in-position”. This is to ensure that all control system dependencies have been properly informed of the recovery and have responded as needed.

Disable

The *Disable* action is designed to put a component into a silent, low-power, low-resource state. While disabled the component will not be publishing telemetry nor monitoring and responding to system events. Disable can only be performed when the controller is in the HALT state.

The intended purpose of this action is to reduce system resources and device interference when the component is not needed. An example of this situation would be during system testing and calibration when the operator only wants to interact with a portion of the control system. Disabling extraneous devices reduces the chances of interference and the risks to personnel that may be in the AO or Laser facilities.

Another example where devices will regularly be disabled will occur during system reconfiguration while setting an observing mode (see [SetMode](#)). When switching between the various observing modes certain devices will not be needed, and may in fact interfere with observing if they were to be accidentally issued a command. Disabling the associated controller will prevent the accidental commanding of these devices.

In order to re-enable a disabled component for use a *Home* action must be performed. As with a standard home operation the device will go through an initialization process and zero its encoder positions. Once the home and initialization is complete the device can be commanded normally.

Outputs

State

Health

4.4 Low Level Motion Device Control

The devices to be controlled by AO Controls are many, and are detailed in the configuration controlled [KAON 682: NGAO Master Device List](#) spreadsheet. As of this writing there are a total of 83 motion

Comment [ktt1]: New section



devices, 29 of which are laser devices. There are also a substantial number of non-motion devices that is covered under the AO Control System. One thing to note is that AO Controls does refer to real-time control of devices, as in realtime control of deformable or tip-tilt mirrors, but to the basic control of the devices themselves. This includes power control, initialization, basic parameter control, etc...

Motion control refers to the control of any device that has to be positioned before it can be used. This control depends on the type of motion device being controlled. The particular devices are being designed in parallel and is described in [KAON 715: NGAO Preliminary Motion Control Design](#).

Although we haven't converged on a particular hardware control system, we are very familiar with Delta Tau PMACs as they are used extensively in our current AO and Interferometer systems so the current thought is to stick with it especially given its programmability and scalability. The only difference may be in the use of different form factor migrating away from VME to a smaller PXI/CPCI form factor. Also, for low precision intermittent motion devices we may use smart motors for simplification of cabling as they can be chained together and would be controlled over a serial interface.

The low level motion control functions consist of one or more device drivers that implement an API for interacting with the motion control system to provide the most basic level of motion control. This device driver will most likely be supplied by the manufacturer of the motion control electronics. Layered on top of the manufacturer's device driver will be another driver providing an interface to the AO control system. At the top of this control block is a generic state machine that implements the basic coordinated functions required for controlling a motion control device with an arbitrary number of degrees of freedom. This concept is used in the existing Keck AO and Interferometer systems.

Currently, the following device types/categories for motion devices have been identified in KAON 715, from least complicated to control to most demanding, they are:

- Shutters
- Low precision non-tracking devices
- Medium precision non-tracking devices
- High precision non-tracking devices
- Tracking devices
- Extremely high precision tracking and non-tracking devices
- Coordinated high precision tracking and non-tracking devices

From a software perspective, these can be grouped into the following generic categories:

- discrete commanded devices
 - o shutters
- non-tracking devices
 - o low precision non-tracking devices
 - o medium precision non-tracking devices
 - o high precision non-tracking devices
 - o extremely high precision non-tracking devices
 - o coordinated high precision non-tracking devices
- tracking devices
 - o tracking devices
 - o extremely high precision tracking devices
 - o coordinated high precision tracking devices

which are described in the following sections. The intent would be to develop each type once and instantiate it for all the necessary devices. This will simplify implementation and allow for quick and easy changes or additional devices.



4.4.1 Discrete Commanded Devices

4.4.1.1 Description

This is the simplest of device types and consists of simple in/out devices with loose positional requirements, actuators other than motors (e.g., solenoid, pneumatic, etc), and devices with switches or hard stops used to define positions.

Software controls for this device type will involve sending a discrete output signal to a digital I/O controller board and status information will be returned in the same manner. More than likely the status will consist of limit switch readings where only one limit can be active at any given time. When no limit switches are active, this indicates that the device is between positions and thus assumed to be “travelling”. When both limit switches are active, this indicates an error.

4.4.1.2 Inputs

Commands to this device type will be simple boolean 0 or 1 commands where 0 means one state and 1 means the opposite state. For instance open/close or in/out.

4.4.1.3 Outputs

Since these are simple discrete devices, the outputs will consist of two boolean state readback values which will indicate opposite positions, i.e. open/close, in/out, or cw/ccw, etc... A valid status will be when only one state is active and the other is open. When both states are open, this indicates that the device is travelling between states. When both states are active, this will indicate a fault condition.

4.4.2 Non-tracking Devices

4.4.2.1 Description

Non-tracking positional devices are devices that can be positioned anywhere within a maximum position range. Examples of non-tracking devices are:

- dichroics
- fold mirrors
- focus stages
- lenslet stages

These devices are positioned during configuration or acquisition and then left in place with its servo loops open, i.e. no power. They are not moved during an observation. There will be varying degrees of precision: low, medium, and high, all based on encoder resolution with matching DAC output control. However from a software perspective these are all treated the same. They must all be initialized, which means that their encoders must be homed. This involves driving to a home switch, which could be a limit switch, and loading a particular position once the switch is sensed then applying a home offset to position the device to a known position. Depending on the device, this could be a specific position or some where in the middle of travel, where we call encoder position 0. This homing process is built into the PMAC and can be configured on a motor by motor basis as to which direction to home and what to use for a home switch as well as the specific home offset.

Once the device is homed, it will then need to be positioned to specific locations such as in beam or out of beam. This will be done by using named positions instead of actual position values or encoder counts. The named position will be mapped to a specific encoder position which can change as needed but the named position used will always be the same, i.e. in-beam, out-beam, etc.

For some devices, i.e. focus stage or a lenslet stage, positioning will need to be based on actual positions then adjusted throughout the night. The initial position, in the case of a focus device, will be pre-calibrated



and can have a named position, such as initial-focus, but subsequent moves / adjustments will need to be commanded in some form of engineering unit that is logical to the device. So instead of adjusting focus by some number of encoder counts, you would specify a move in terms of millimeter of focus, for instance.

4.4.2.2 Inputs

- Home / Initialize command
- Abort command
- Move to named position command
- Move to logical unit position command
- Move to raw encoder count command

4.4.2.3 Outputs

- Current position in
 - o raw encoder counts
 - o equivalent logical unit position
 - o applicable named position
- In position status
- Home status
- Servo loop status
- DAC output
- Following / position error
- Limit conditions

4.4.3 Tracking Devices

4.4.3.1 Description

Tracking devices are devices that are constantly commanded to a new position during an observation which is based on and synchronized with an external source, i.e. telescope az or el, and is updated at a fixed rate. Like non-tracking devices, tracking devices require various levels of precision as well as coordination of moves with other DOFs, i.e. steering mirrors, and in some cases spatial position constraints to avoid collisions, i.e. pickoff arms.

From a software perspective, tracking devices are basically non-tracking devices with the added capability of being able to handle continuous position demands without having to open its servo loop after each move. Ideally the controller will be able to handle velocity and position loops to help keep motion smooth and constant.

4.4.3.2 Inputs

- Home / Initialize command
- Abort command
- Move to named position command
- Move to logical unit position command
- Move to raw encoder count command
- Continuous tracking demanded position commands

4.4.3.3 Outputs

- Current position in
 - o raw encoder counts
 - o equivalent logical unit position



- applicable named position
- In position status
- Home status
- Servo loop status
- DAC output
- Following / position error
- Limit conditions

Comment [ktt2]: New section; still in progress

4.5 Low Level Non-Motion Device Control

As defined by [KAON 668: NGAO Device Control Architecture](#), non-motion device control refers to the control of any device or subsystem that is not creating motion, i.e. motion control, and is not one of the devices requiring real-time control for wavefront sensing and correction. This includes power control, environmental control, camera control, mirror control, general sub-system control (e.g., the laser units, the RTC) and the controls infrastructure.

Non-motion device control is, in general, low speed without tight timing constraints; the commands are frequently single events (e.g., GUI button press) and are expected to be executed on the timeframe of seconds. Ethernet will be the primary means of communicating with devices for control. If a device does not have an Ethernet interface, there may be simple Ethernet solutions which exist (e.g., terminal servers to communicate with RS-232 based devices, or digital I/O modules with an Ethernet interface to generate digital I/O signals). To reduce software integration efforts, Ethernet devices should support an industrial protocol (Modbus TCP/IP, Fieldbus, etc) rather than a web (HTTP) based interface whenever possible.

Through the adoption of Advance Technology Solar Telescope's (ATST) Common Services Framework (CSF) for Keck, aka: KCSF, the software controls will be defined such that the lowest level device driver will always be hidden from the higher level control system. This means that there will be a common interface to each device regardless of the underlying hardware, which is referred to as device attributes. The NGAO and TCS Upgrade projects are working in conjunction with each other on this common framework for eventual use throughout the observatory. For more details on KCSF refer to the [NGAO Software Architecture Mini-Review](#) Twiki page.

Figure 3 Generic KCSF Device Interface Layer illustrates the concept of a generic IDaqDevice interface taken from a TCS Upgrade example. The DAQ specific controller would be created to match the IDaqDevice interface. In this case we show the use of the NIDAQ Device Controller. This device controller uses the [NI-DAQmx API](#) from Nation Instruments and supports the [ICE](#) IDaqDevice interface. The NI-DAQMmx drivers supports a number of device types:

- Multifunction DAQ
- Analog output
- Digital input/output
- Counter/timer
- High speed digitizer
- Dynamic signal acquisition

A DAQ Client will run as part of the application and will be responsible for setting up the IO, alarming and reading/writing to the devices via the ICE interface

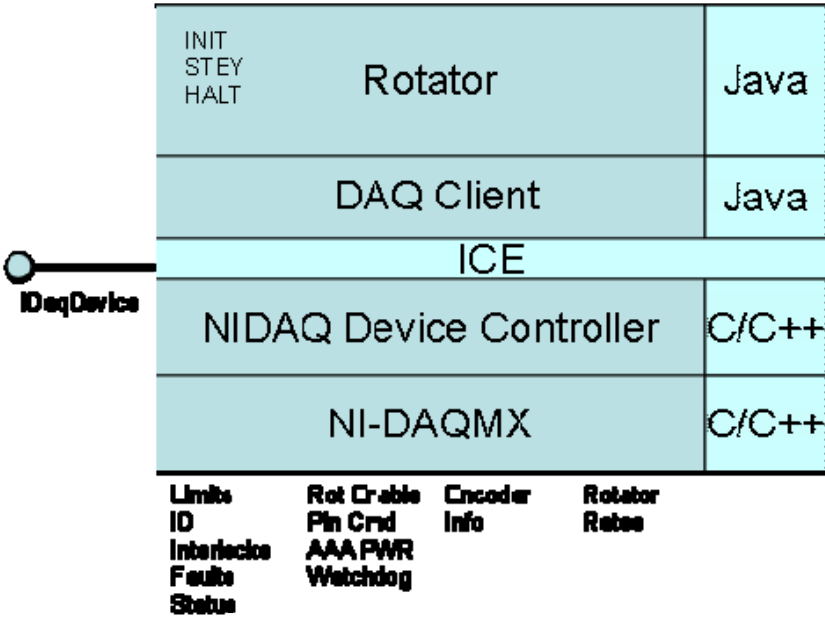

Figure 3 Generic KCSF Device Interface Layer

Serial and TCP/IP interface device types which are not supported by NI-DAQmx, would be handled as part of the KCSF infrastructure device/controller concept. For more details refer to [KAON 679: NGAO Control Software Architecture](#).

The following sections describe the various types of device control which would be supported by this device layer.

KAON 668 specifies the following device control methods:

- Remote power control
- Camera / detector control
- Digital input/output
- Analog input
- Analog output
- Remote reset control
- Video
- RS-232 and USB
- Ethernet
- Time distribution / synchronization

These can be further broken down to:

- Serial interface (terminal server)
 - o RS-232
 - o RS-422/485
 - o USB
 - o COTS Controllers
- Ethernet
 - o COTS Controllers
- Analog I/O
- Digital I/O



- Remote reset control
- Video
- Camera / Detector Control

4.5.1 Remote Power Control

Remote power control is used to power on / off devices remotely through COTS power controller device. The observatory currently uses two different supplied power controllers ([Pulizzi](#) and [APC](#)) both of which are serial device types. Serial device types would be custom implemented using KCSF's device/controller concepts.

Should a more customized solution based on solid state relays and digital controls as mentioned in KAON-668 be necessary, it would easily fit into KCSF's generic iDaqDevice interface.

4.5.1.1 Inputs

Execute command attributes:

- Power on <port# | all>
- Power off <port# | all>

4.5.1.2 Outputs

Get command attributes:

- Port status

4.5.2 Camera / Detector Control

Control of the various cameras and detectors used in the system is complicated by the fact that some of the cameras have control interfaces that are part of the data readout interface, as is the case with Camera Link. For these cameras, the control functions will be implemented directly by the RTC, but the RTC is required to make specific control commands available to the NGAO control system for initiation of these functions.

For the other cameras and detectors, the control interface will depend on the specific controllers that are selected. The Sidecar ASIC, which is under consideration for the LOWFS, interfaces to the RTC via USB. This scenario is similar to the cameras with the Camera Link interface where the device is controlled through RTC. A camera controller with an Ethernet interface, or the requirement for a dedicated server, would be an example of a system where the RTC might not be required to implement configuration and diagnostic functionality; the NGAO control system could talk directly to the camera controller (or server).

The control requirements for each camera must be analyzed on a case by case basis once the design is understood.

4.5.3 Discrete (Digital) Input/Output

Several options exist to implement this requirement. A VME or PCI card could be used in conjunction with a CPU, as is done in the current system. Alternatively, Ethernet (or serial) I/O modules exist (Acromag, B&B and others) that perform the same function without requiring a CPU/Backplane. The use of distributed modules could simplify wiring.

Digital inputs and outputs will be required to control custom on/off devices, provide remote reset capability for equipment and read back the state of equipment.

4.5.4 Analog Input

As with the digital I/O, a VME or PCI card could be used in conjunction with a CPU, as is done in the current system. Alternatively, Ethernet (or serial) I/O modules exist (Keithley, B&B and others) that



perform the same function without requiring a CPU/Backplane. This approach will accommodate both voltage and current type sensors. The use of distributed modules could simplify wiring.

Analog inputs will be required to digitize signals from sensors. Examples are environmental temperature sensors and intensity feedback from the stimulus sources.

4.5.5 Analog Output

Analog signals can be generated via a peripheral card installed in a VME system or by a stand-alone module connected to the Ethernet. Channel density, speed and latency requirements will probably dictate the type of source.

Analog outputs may be required to modulate the intensity of stimulus source intensity and to ramp the output of high voltage power supplies. This could also be used as the control command for low bandwidth, open loop PZT devices.

4.5.6 COTS Controllers

A number of off the shelf controllers will be required to provide monitoring/control the environment and instruments. In some cases, a sensor will be connected to an analog input described above. In other cases, controllers such as a Lakeshore temperature controller, Varian ion pump controller, or similar device will be used. These controllers will be fitted with either a serial or Ethernet interface to allow connection to the control system.

4.5.7 Remote Reset control

Another functionality that has proven useful is the ability to remotely reset equipment, specifically VME backplanes, without cycling power. The existing design (119-70-00) is a 1U package, based on a digital I/O module with a serial interface, which implements eight optically isolated outputs, each with local/remote capability. The outputs are the emitter and collector of the opto-isolator transistors. Internal configuration can include a pull up resistor and/or grounding the low side of the transistor. The serial to I/O module used in this design is obsolete, so a replacement module will need to be sourced.

4.5.8 Video

Video encoders (servers) manufactured by [Axis](#) communications are currently used at the observatory and can be used for NGAO as well. These simple devices convert an analog video signal to Ethernet, allowing web based viewing/configuration. The Interferometer uses software to processes the network video stream and obtain centroids that are used for automatic beam train alignment.

4.5.9 RS-232 and USB

The goal is communicate with every controllable device via Ethernet. To accomplish this, some equipment will require a protocol converter. [Lantronix](#) terminal servers are currently used for RS-232 and RS-422/485 devices. Lantronix also produces a USB server, should that functionality be required.

4.5.10 Ethernet

Devices will connect to the Ethernet via a managed switch. Managed switches allow creation of 'V-LANs' that help route network traffic and optimize data flow. Currently HP products are used.

4.5.11 Time Distribution / Synchronization

Two types of synchronization are required for NGAO. First, many of the components will need a precise UTC reference. In addition, the distributed components of the RTC subsystem have an extremely tight internal synchronization requirement. Fortunately, this does not extend to the UTC reference.



Existing observatory infrastructure distributes a GPS time signal via the IRIG-B protocol. Each system requiring a UTC reference makes use of a local VME decoder board. This method is capable of delivering microsecond level accuracies, if care is taken to account for propagation delays in the cabling. Components with relaxed requirements, generally servers and PCs, use the Network Time Protocol (NTP) to synchronize their local clock. It is not clear if this is done at any time other than boot-up, so the initial millisecond level accuracy degrades rapidly. It is also not clear how the local NTP server is synchronized to UTC.

There have been investigations into the use of the Precision Time Protocol (PTP, IEEE-1588) within NGAO (and the Telescope Drive Control Upgrade project), as an alternative to IRIG-B, to synchronize distributed equipment to a master clock and Universal Coordinated Time (UTC) as derived from Global Positioning System (GPS) satellites. PTP uses Ethernet messages to determine (and manage) the offset between distributed equipment and a master clock. Synchronization with sub-microsecond accuracies is readily achievable. Adoption of PTP would greatly reduce the amount of IRIG-B hardware at the possible expense of additional network infrastructure. This work is ongoing and a final decision has not been made.

A custom system will need to be engineered to synchronize the RTC components. Precision high frequency oscillators and careful attention to propagation delays will be required. Fiber-optic may be used for signal transport to ease transmission line effects over long distances. It is assumed that this work will be handled by RTC design team, collaborating with Keck engineers to ensure the system can be integrated into the facility.

5 AO System

5.1 Introduction

Comment [ktt3]: Updated section

For the preliminary design we've chosen to diverge from the original concept presented in [KAON 569: NGAO System Design Report, Non-Real-Time Controls](#). We are proceeding with a more subsystem view approach to help us better visualize and map the control system to the way the hardware is actually laid out. The original concept had us treating each device as a standalone entity sitting off by itself. Software wise the same functionality will still be developed but by visualizing things from a system perspective it helps us to better understand how the pieces fit together and ultimately how the system will function as a whole. This new view is shown in Figure 4 below.

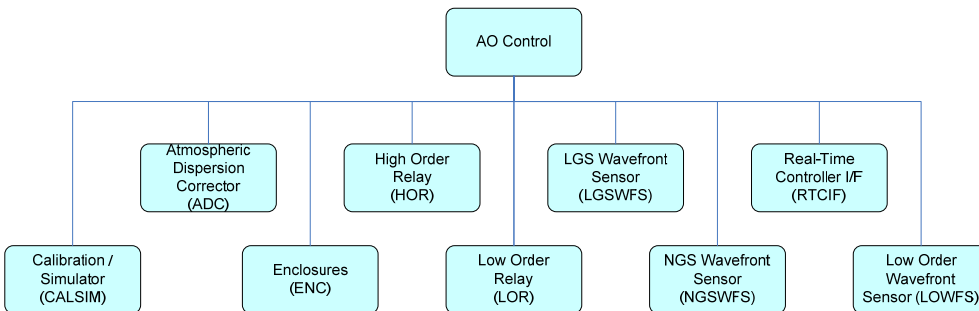

Figure 4 AO Control Block Diagram

You can consider each block as a high level control state machine that implement the complex coordinated control required by the devices in that subsystem. They accept high level commands from the AO sequencer and issue the appropriate commands to the low-level motion control blocks. The sequences will



be implemented using a state machine compiler (SMC). The high level motion control sequences identified above are described in detail in the following sections.

5.2 Low Order Relay

5.2.1 Description

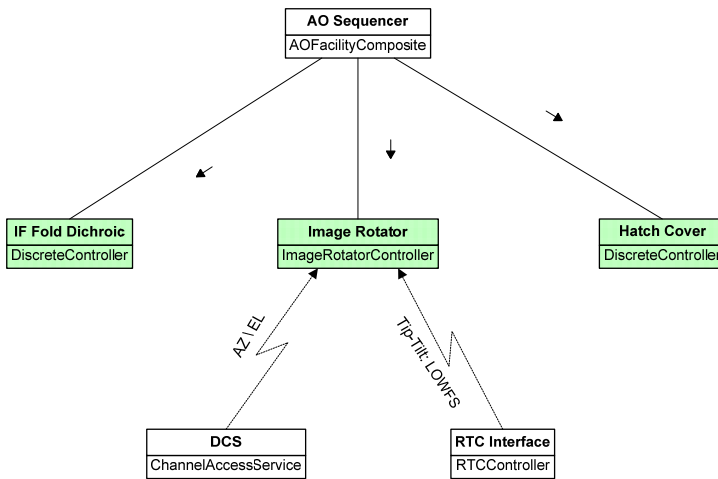

5.2.2 Interfaces

5.2.2.1 Inputs

5.2.2.2 Outputs

5.2.3 Control Loops

5.2.3.1 Image Rotation

5.2.4 Devices

5.2.4.1 IF Fold Dichroic



5.2.4.2 **Image Rotator**

5.2.4.3 **Hatch Cover**



5.3 Acquisition System

5.3.1 Description

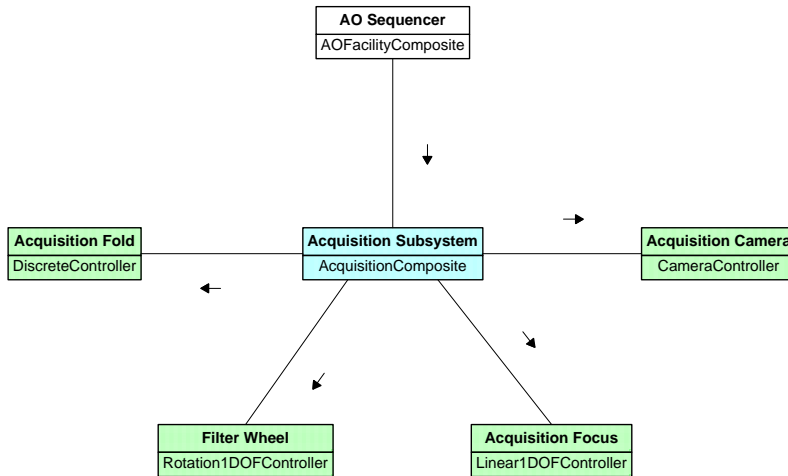

5.3.2 Interfaces

5.3.2.1 Inputs

5.3.2.2 Outputs

5.3.3 Control Loops

The Acquisition System does not implement any control loops.

5.3.4 Devices

5.3.4.1 Acquisition Fold

5.3.4.2 Filter Wheel

5.3.4.3 Acquisition Focus Stage

5.3.4.4 Acquisition Camera



5.4 LGS Wavefront Sensors

The Laser Guide Star (LGS) Wavefront Sensors (WFS) are used by the RTC to determine the appropriate corrections to apply to the low-order deformable mirrors (woofer and LOWFS) to correct for atmospheric turbulence.

There are a total of seven LGS WFS: four are used to perform tomographic correction; the remaining three are used to perform localized corrections for each of the three tip-tilt stars. The four tomographic WFS are stationary within the LGS assembly, and are used by the RTC to calculate the three dimensional atmospheric profile along the telescope seeing. The real-time corrections are applied directly to the low-order DM. The wide-field PnS WFS each have their own 2-DoF pickoff arm that allows the LGS subsystem to acquire the PnS LGS beacons from anywhere within the field. A caveat to this is that the pickoff arms can not cross the central 10 arcsecond of the field (science instrument FoV), and can not occlude any of the other pickoff arms. The wide-field WFS information is used to correct the atmosphere at each of the tip-tilt (2) and focus and astigmatism stars as seen by the LOWFS. The DMs for each tip-tilt star is located within the LOWFS assembly.

5.4.1 Description

The LGS Wavefront Sensor Subsystem is responsible for the management and control of the LGS wavefront sensors and related hardware. This includes the WFS pickoffs and LGS focus stage.

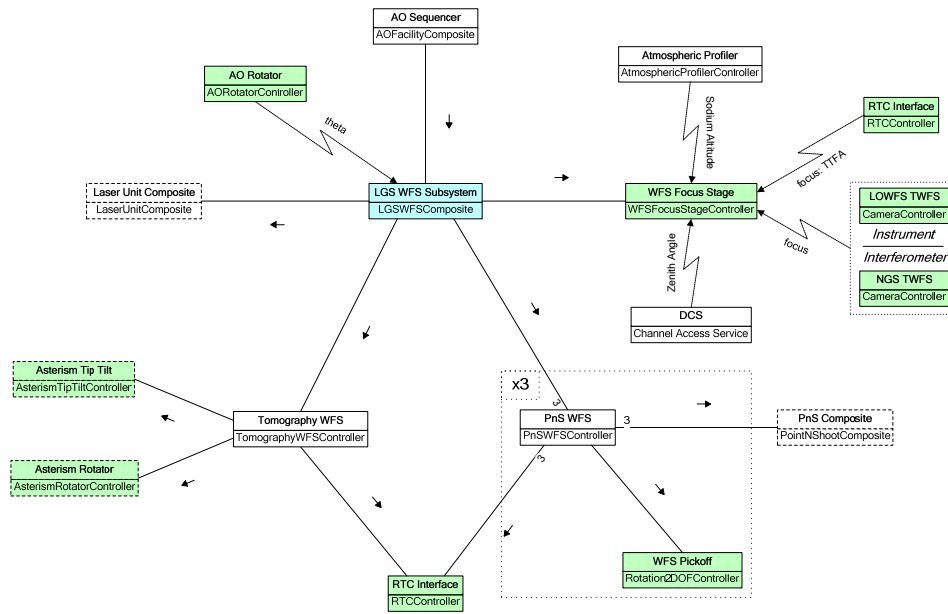

The LGS WFS Subsystem provides the initialization and acquisition functionality to position the wide-field pickoffs; align the PnS and tomography LGS beacons; configure the WFS RTC cameras; and manage the focus for the entire LGS assembly. The LGS WFS Subsystem also provides capabilities to perform background calibrations and respond to alignment errors by offloading to the laser facility up-link tip-tilt and asterism rotator.



5.4.2 Interfaces

The following sections detail the input and output interface to the LGS WFS subsystem controller.

5.4.2.1 Inputs

The primary inputs to the LGS WFS composite are implemented as KCSF actions. Actions are defined through an attribute list and may contain parameters. The following define all of the recognized actions available to the WFS composite.

Home

Initialize

The *Initialize* action is responsible for preparing the LGS WFS subsystem and devices for observing.

SetMode

The *SetMode* action is responsible for configuring the LGS WFS Composite and subcomponents for a particular observing mode. As the LGS WFS are only used during LGS observing, the LGS WFS Composite and subcontrollers will be disabled during NGS observing. The following configurations are used in laser guide star mode:

Fixed-Field LGS (Instrument)

- Enable WFS Focus Stage
- Enable Tomography WFS Controller
- Enable PnS WFS Controllers

Fixed-Field LGS (IF)

- Enable WFS Focus Stage
- Enable Tomography WFS Controller
- Disable PnS WFS Controllers

Fixed Pupil LGS (All)

- Enable WFS Focus Stage
- Enable Tomography WFS Controller
- Disable PnS WFS Controllers

The system must be configured each time the observing mode changes, and must be performed prior to target acquisition and observing.

Background

The *Background* action is responsible for initiating a WFS background calibration. The WFS Composite will open the RTC control loops (if currently tracking); tune the lasers off of the 589nm wavelength; initiate WFS background calibrations and tune the lasers back on.

This action can be performed at any time post-initialization, and can be performed as a system wide performance optimization during observing (this will interrupt the observing sequence). If performed during an observation the WFS RTC control loops will have to be closed through a call to *Acquire* when complete.

Acquire



The *Acquire* action is responsible for aligning the LGS asterism with the WFS, and closing the AO and offload control loops. There are a total of seven WFS: four tomography sensors managed under the *TomographyWFSController*; and three point-and-shoot sensors, each managed by a *PnSWFSController*. Alignment of the LGS beacons will be performed with the WFS as the reference, by commanding the BGS tip-tilt, rotator and point-and-shoot arms. The WFS were selected as the preferred reference because the pickoff devices should be positioned with higher precision and will not be affected by telescope flexure, unlike the BGS which is mounted on the telescope secondary socket.

During the LGS acquisition process the WFS Composite will be provided with the telescope pointing target and the positions of up to three laser beacons. The composite will be responsible for converting these targets into image plane coordinates, taking into account telescope and rotator orientation, and calculating the required positions of the WFS pickoffs. After the devices have been positioned the device controllers will be commanded to acquire their respective laser beacons, and if successful, enter track to close the RTC and offloading control loops.

Halt

The *Halt* action is responsible for opening the control loops and halting the WFS. Motion devices such as the pickoff arms and focus stage will be powered down and RTC will be told to open the AO control loop and idle the sensors. The devices and control loops can be reacquired with a call to *Acquire*.

Recover

The *Recover* action is a state dependent process that is responsible for recovering the WFS Composite and controllers in the event of a fault. During observing if the pickoff arms, focus stage, or WFS sensors enter a fault state observing may be interrupted. Rather than requiring a full subsystem initialization to clear the fault – consequently ending the science sequence – a recover can be issued, which will selectively reinitialize the faulted devices only. If the fault can be cleared the device(s) will be put back into its previous state prior to the fault, and observing should be able to continue, uninterrupted.

Disable

The *Disable* action will power down the RTC WFS and devices, and put the controllers into an idle (low network / resource usage) state. Disable is typically performed at the end of a nights observing or when the device is no longer need, for example when switching to NGS mode. While DISABLED the controller will not be publishing telemetry nor monitoring and responding to system events. A *Home* must be performed to re-enable the device and controller for use. Disable can only be performed when the controller is in a halted state.

5.4.2.2 Outputs

LGS WFS Composite outputs are made available as KCSF events. Each event is identified by a unique name.

5.4.3 Control Loops

The following sections detail the tracking and offload control loops of the LGS WFS subsystem. Each control loop is implemented in part of in full by one or more of the NGAO controllers.

5.4.3.1 WFS Focus

As a tracking device, the WFS Focus Stage Controller will be monitoring the state of the system and responding to events. Focus information is derived from the atmospheric conditions, LOWFS calculated focus, and the telescope zenith angle.

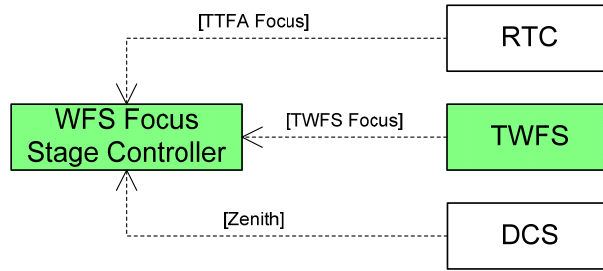

WFS focus tracking is an event driven control loop triggered by telemetry events from the RTC, the TWFS camera, and DCS telescope zenith angle keywords. The RTC provides time-averaged data from the Tip-Tilt Focus and Astigmatism (TTFA) WFS to determine the approximate height of the sodium layer. More accurate focus information is provided at a slower rate (~1Hz) directly by the Truth Wavefront Sensor (TWFS). The TWFS images will be processed by the NGAO controls system to determine focus and centroid offsets and published as telemetry. When the controller receives input from these items it will calculate the LGS WFS focus compensation and apply it to the stage.

5.4.3.2 LGS Offloading

During observing the LGS WFS will periodically have to offload tip-tilt errors to the Beam Generation System to maintain alignment of the LGS beacons. The tip-tilt offload loop is different for the tomography and point-and-shoot (PnS) WFS.

Tomography WFS

The Tomography WFS Controller uses a single offload task to manage the tip-tilt offload for all four WFS. Offloads are performed when the average of all the tomography tip-tilt stages exceeds a specified threshold. This task is responsible for maintaining a balanced tip-tilt average across the entire asterism.

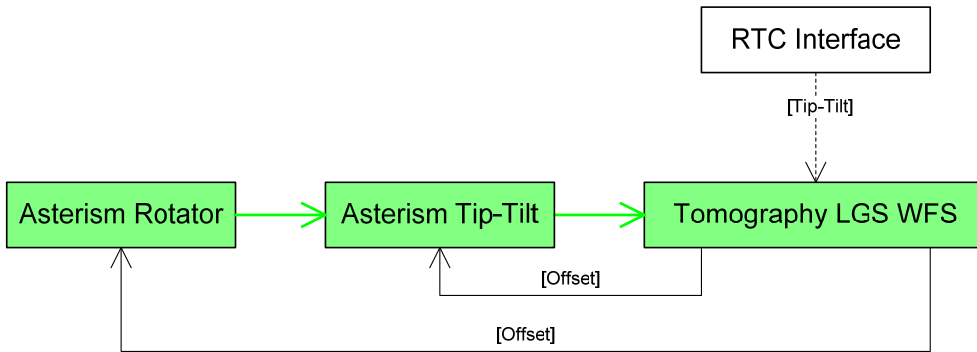

Tip-tilt information from each of the WFS TT mirrors is provided through the RTC telemetry, and is used to calculate average tip-tilt across the tomography sensors. The offload task will determine the offset to apply to the BGS up-link Tip-Tilt and Rotator for asterism shift and rotation, respectively. The BGS offsets will be seen by the WFS as rapid motion away from the increasing tip-tilt. This will result in the RTC compensating by moving the WFS TT mirrors towards their zero point.



Point-and-Shoot WFS

Each of the PnS WFS Controllers implements their own tip-tilt offload control loop. This loop is responsible for periodically offloading the accumulated tip-tilt of the WFS TT mirror (the mirror itself is controlled by RTC) to the BGS PnS steering arm.

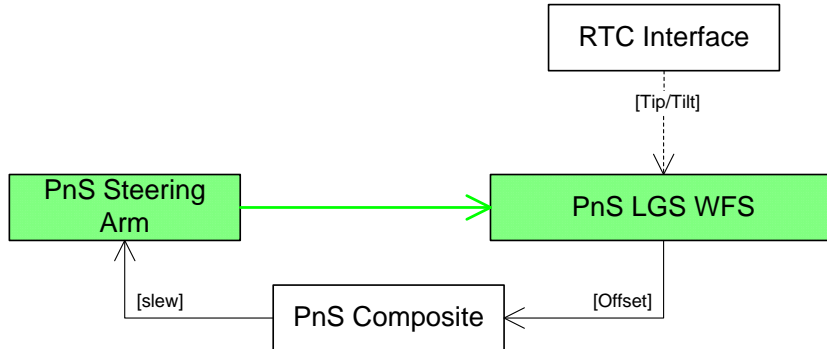

When the RTC WFS loop is closed the real-time system will be using the WFS tip-tilt mirror to keep the LGS spot stable on the sensor. Over time the tip-tilt will build up and if not offload can cause the TT mirror to reach its limit, and eventually lose the LGS beacon all together. When the tip-tilt exceeds a defined threshold, the LGS WFS Controller will calculate the offset required by the steering arm to bring the beacon closer to true center (zero tip-tilt). The WFS will see this as the beacon moving rapidly out of center in the opposite direction of drift, and will compensate by moving the TT mirror to bring the spot back to center. This should consequently return the TT mirror to near its center of range of motion.

5.4.4 Devices

The following devices are managed by the LGS WFS subsystem. Specific details, interfaces, and discussions are available in their related design documents.

5.4.4.1 Focus Stage

All seven LGS WFS are mounted on a rigid assembly. Focus for the wavefront sensors are achieved by moving the entire assembly along the z-axis with a linear 1-DOF focus stage. The required position of the stage is based on focus measurements determined by the TTFA LOWFS, and at a slower rate by the TWFS. The TTFA measurements are produced by RTC, while the TWFS focus control loop is implemented directly by the NGAO Controls system.

5.4.4.2 Pickoff Arms

The three wide-field Point-and-Shoot LGS wavefront sensors utilize a 2-DOF rotational pickoff arm to acquire their LGS beacons from the field. The pickoff arms are based on a theta-phi motion control design, allowing each WFS to pickoff a target anywhere in the field. Although the three pickoff arms are stacked along the optical axis to prevent physical collision with each other, motion control and positioning requirements exist to prevent vignetting of the science field and ensure the safety of the system.



5.4.4.3 LGS WFS

Although the seven LGS WFS perform different functions in the NGAO system, they share identical hardware and similar control interfaces. The wavefront sensors are under the direct control of the RTC subsystem. The NGAO Controls system is responsible for initializing and configuring the WFS cameras, and commanding RTC to open or close the control loops. All four tomography sensors are managed by *TomographyWFSController*. As there are no operating modes where only a portion of the tomography WFS would be active, the Controller exposes a single abstract interface to command all four sensors simultaneously. The three PnS wavefront sensors are each represented by an instance of the *PnSWFSController*. The PnS Controller interface is similar to the tomography controller, but adds additional functionality for slewing the pickoff arms and acquiring the wide-field LGS beacons.



5.5 Low Order Wavefront Sensors

To correct for atmospheric turbulence you need to know how the light is distorted as it travels through the atmosphere. Local turbulence can be imaged by each of the LGS WFS and applied to the first relay DM. The LGS WFS alone though do not provide information about the focus of the system, nor can they be used to detect the overall field tip and tilt. For this, natural guide stars are needed to calculate the tip-tilt caused by the atmosphere, and the required focus of the AO system. This information and functionality is provided by the low-order wavefront sensor (LOWFS) system.

5.5.1 Description

The Low Order Wavefront Sensor subsystem is responsible for the management and configuration of the low order wavefront sensors (LOWFS) and related hardware. The LOWFS are responsible for providing tip-tilt and focus information to the RTC and AO Controls system. RTC will apply corrections to the low-order relay TTM to correct for full-field tip and tilt. Focus and rotation offloading will be managed by the AO Controls and will be applied to the LGS focus stage and AO rotator.

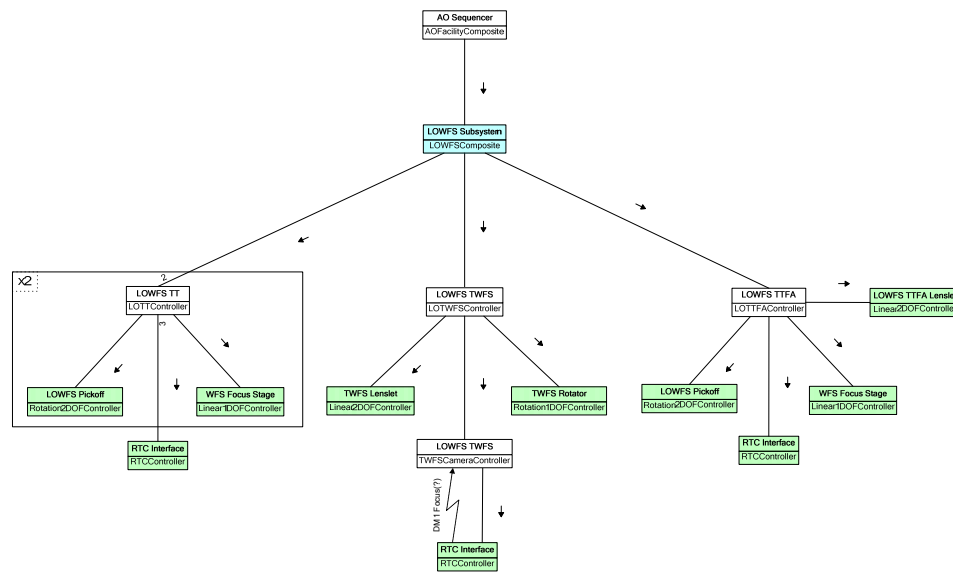

There are a total of three LOWFS assemblies, each with a dedicated deformable mirror, pickoff arm, focus stage, tip-tilt mirror and sensor. In addition to tip and tilt, one of the LOWFS sensors also provides focus and astigmatism information (TTFA) to the RTC. Co-mounted with the TTFA is a truth wavefront sensor (TWFS). This sensor provides more accurate focus information, but at a slower rate than the TTFA. The TWFS sensor is under the direct management and operation of the AO Control system.

All three LOWFS and the TWFS are managed by the *LOWFSComposite*. This NGAO component provides a simple interface to initialize, acquire, and manage the devices during observing. The following sections detail the LOWFS Composite.



5.5.2 ***Interfaces***

The following sections detail the input and output interface to the LOWFS subsystem controller.

5.5.2.1 ***Inputs***

The primary inputs to the LOWFS composite are implemented as KCSF actions. Actions are defined through an attribute list and may contain parameters. The following define all of the recognized actions available to the LOWFS composite.

Home

The *Home* action is responsible for creating network connections, powering on devices, and initiating the homing sequences. The home action is a larger process of system initialization and will automatically perform and *Initialize* when complete.

Initialize

The *Initialize* action is responsible for preparing the LOWFS subsystem and devices for observing. This includes setting default RTC sensor parameters; initializing the pickoff arms, focus stages, and lenslet stages; and refreshing component and telemetry connections.

SetMode

The *SetMode* action is responsible for configuring the system and devices for observing in a particular mode. The LOWFS hardware is only used when there are laser corrected tip-tilt stars, which exists only in Fixed Field LGS instrument observing (non-IF). The LOWFS composite and subcontrollers will be disabled during fixed pupil, fixed field IF, and NGS observing.

The system must be configured each time the observing mode changes, and must be performed prior to target acquisition.

Acquire

The *Acquire* action is responsible for aligning the NGS tip-tilt targets with the LOWFS, and closing the AO control loops. There are a total of three LOWFS: two tip-tilts, implemented by the *LOTTController*; and one TTFA, implemented by the *LOTTFAController*. All three LOWFS controllers share the same acquisition sequence and are treated identically from the perspective of the LOWFS Composite.

During the NGS acquisition process the LOWFS Composite will be provided with the telescope pointing target and the positions of up to three tip-tilt targets. The composite will be responsible for converting these targets into image plane coordinates, taking into account telescope and rotator orientation, and calculating the required positions of the LOWFS pickoffs. After the devices have been positioned the controllers will be commanded to acquire their respective stars. This will peak-up NGS alignment and determine the appropriate seeing parameters to apply to the RTC cameras. When the acquisition completes a background will be performed and the controllers will be put into track to close the RTC control loops.

Background

The *Background* action is responsible for initiating a sequential background calibration of all three LOWFS, and can only be performed after the LOWFS have been acquired. Essentially, this action exists to perform servo loop optimizations while observing without interrupting the science sequence. The following actions are performed for each LOWFS controller:

1. Issue a *Background* command. This will open the control loops, offset the pickoff arm, take a background over the region of interest, and reacquire the NGS.
2. Issue a *Track* command. This will close the LOWFS control loops.

This action can be performed at any time post-acquisition, and is typically performed as a system wide performance optimization during observing. If new frame rates are required they should be specified at the LOWFS Controller level before initiating a background. If only one or two LOWFS need to be recalibrated



the background should be done individually, rather than being performed from the LOWFS Composite level. Performing a background during observing should be done sequentially to avoid having to interrupt the observing sequence.

Halt

The *Halt* action is responsible for opening the control loops and halting the LOWFS. Motion devices such as the pickoff arms and focus stages will be powered down and RTC will be told to open the AO control loop and idle the sensors. The devices and control loops can be reacquired with a call to *Acquire*.

Recover

The *Recover* action is a state dependent process that is responsible for recovering the LOWFS Composite and controllers in the event of a fault. During observing if the pickoff arms, focus stages, or LOWFS sensors enter a fault state observing may be interrupted. Rather than requiring a full subsystem initialization to clear the fault – consequently ending the science sequence – a recover can be issued, which will selectively reinitialize the faulted devices only. If the fault can be cleared the device(s) will be put back into its previous state prior to the fault, and observing should be able to continue, uninterrupted.

Disable

The *Disable* action will power down the RTC LOWFS and devices, and put the controllers into an idle (low network / resource usage) state. Disable is typically performed at the end of a nights observing or when the device is no longer need, for example when switching to NGS mode. While DISABLED the controller will not be publishing telemetry nor monitoring and responding to system events. A *Home* must be performed to re-enable the device and controller for use. Disable can only be performed when the controller is in a halted state.

5.5.2.2 Outputs

LOWFS Composite outputs are made available as KCSF events. Each event is identified by a unique name.

5.5.3 Control Loops

The following detail the control loops managed by the LOWFS subsystem.

5.5.3.1 TWFS Focus and Centroiding

The TWFS Controller will be responsible for processing images to determine high accuracy focus and centroiding errors. A Shack-Hartmann technique is used to estimate the wavefront and calculate the overall focus of the light and its average centroid. The focus information will be published to the LGS WFS focus stage, and centroid information will be sent to RTC to improve AO corrections.

5.5.4 Devices

The following details all of the devices managed by the LOWFS subsystem.

5.5.4.1 LOWFS Pickoffs

Each LOWFS sensor utilizes a 2-DOF rotational pickoff arm to acquire the NGS targets from the field. The pickoff arms are based on a theta-phi motion control design, allowing each LOWFS to pickoff a target anywhere in the field. Although the three pickoff arms are stacked along the optical axis to prevent physical collision with each other, motion control and positioning requirements exist to prevent vignetting of the science field and ensure the safety of the system.



5.5.4.2 Focus Stages

Each LOWFS unit is mounted onto a 1-DOF linear focus stage. Focus for each LOWFS must be conjugate to the science instrument and is affected by the position of the TT target in the field; optics in the science path; and the configuration of the instrument itself. As the focus for the science instrument shouldn't change during observing the LOWFS focus position should only need to be set at the beginning of a sequence. If optics any hardware is added, removed, or reconfigured in the beam train that may affect the focus the LOWFS focus position will need to be recalculated and applied.

5.5.4.3 Lenslet Array

The TTFA and TWFS LOWFS utilize a lenslet array to determine the structure of the arriving wavefront, after low-order corrections by the DM. As the shape of the DM is based on the atmospheric turbulence seen by the LGS WFS, any remaining aberrations in the wavefront indicate what was not able to be removed by the low-order correction. This includes field tip-tilt and LGS focus errors. RTC will directly calculate the focus error as seen by the TTFA. The NGAO Controls system will be responsible for processing the TWFS images to determine focus errors. The RTC and TWFS controller will publish the errors, which will be used by the LGS WFS focus tracking control loop.

5.5.4.4 TWFS Camera

Unlike the other LOWFS sensors, the TWFS is under the direct control and management of the NGAO Control system. The TWFS Controller implements the functional control logic for the sensor, and exposes a simple interface to initialize, configure, and control TWFS image processing. The controller is responsible for providing the slow-rate focus and centroid calculations to RTC to optimize system performance.

5.5.4.5 TWFS Rotator

Comment [dm4]: I'm guessing this is to maintain the same orientation of the spot as seen by either the TTFA or LGS WFS, but I'm not sure.



5.6 High Order Relay

5.6.1 Description

Currently the only device in the High-Order relay under the NGAO software system's control is the High-Order Tip-Tilt mirror.

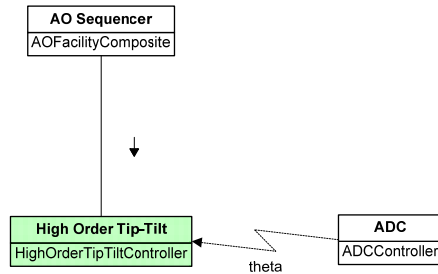

The high-order tip-tilt device (TTM2) acts as the mount for the second relay (high-order) DM, and is under the direct control of the NGAO controls system. As a low-bandwidth device, TTM2 is used primarily for offloading and tracking of differential atmospheric refraction (DAR) and the Keck Angle Tracker (KAT). In addition any pre-measured tip-tilt errors from the atmospheric dispersion compensator (ADC) can also be offloaded to TTM2.

5.6.2 Interfaces

The following sections detail the input and output interface to the High-Order Tip-Tilt controller.

5.6.2.1 Inputs

The primary inputs to the High-Order Tip-Tilt controller are implemented as KCSF actions. Actions are defined through an attribute list and may contain parameters. The following define all of the recognized actions available to the High-Order Tip-Tilt controller.

Home

Initialize

The *Initialize* action is responsible for preparing the high-order tip-tilt device for use.

Slew

The *Slew* action causes the high-order tip-tilt device to move to the specified position.

Track

The *Track* action causes the tip-tilt device to enter track mode. While in track the Controller will listen to position events from the ADC, and using a table of premeasured tip-tilt values, offload the ADC TT errors to the device. The Controller will remain in track until a *Halt* is issued.

Zero

The *Zero* action removes any offset applied to the device through the *Offset* attributes. This is similar to setting an offset of (0, 0). The *Zero* action can be executed from any state.



Halt

The *Halt* action is responsible for halting device motion (power-down) and taking the controller out of the TRACK state. Halt can be issued from any of the post-initialization states.

Recover

The *Recover* action is a state dependent process that is responsible for recovering the High-Order Tip-Tilt Controller in the event of a fault. During observing if the device center a fault state observing may be interrupted. Rather than requiring a full subsystem initialization to clear the fault – consequently ending the science sequence – a recover can be issued, which will selectively reinitialize the faulted device only. If the fault can be cleared the device will be put back into its previous state prior to the fault, and observing should be able to continue, uninterrupted.

Disable

The *Disable* action will power down the device and put the software controller into an idle (low network / resource usage) state. Disable is typically performed at the end of a nights observing or when the device is no longer need, for example when switching to NGS mode. While DISABLED the controller will not be publishing telemetry nor monitoring and responding to system events. A *Home* must be performed to re-enable the device and controller for use. Disable can only be performed when the controller is in a halted state.

5.6.2.2 Outputs

High-Order Tip-Tilt controller outputs are made available as KCSF events. Each event is identified by a unique name.

5.6.3 Control Loops

5.6.3.1 ADC Tip-Tilt Errors

It is expected that the Atmospheric Dispersion Compensator (ADC) will cause position translation errors in the science image. Fortunately these errors can be compensated for by the High-Order Tip-Tilt device.

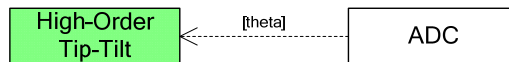

The HO Tip-Tilt will listen to position events from the ADC, and using a table of premeasured tip-tilt error values find the appropriate compensation to apply to the stage.

5.6.4 Devices

5.6.4.1 High-Order Tip-Tilt stage



5.7 NGS Wavefront Sensor

Just after the high-order relay is the natural guide star WFS system. This system is responsible for calculating the wavefront, tip-tilt, and focus of a guide star in NGS mode, and applying the corrections to the low and high-order relays (depending on instrument). The NGS subsystem can also provide truth and focus information to the Real-Time Control system during laser guide star observing, which is required by the Interferometer.

5.7.1 Description

The NGS WFS Subsystem is implemented by the *NGSWFSComposite*, and is responsible for the management and operation of the natural guide star (NGS) devices. This includes the NGS WFS, focus stage, lenslet array, and field steering mirrors. The Composite presents a simple high level interface to the client to initialize, configure, and acquire guide stars from the field. The NGS WFS Composite is managed directly by the AO Sequencer subsystem.

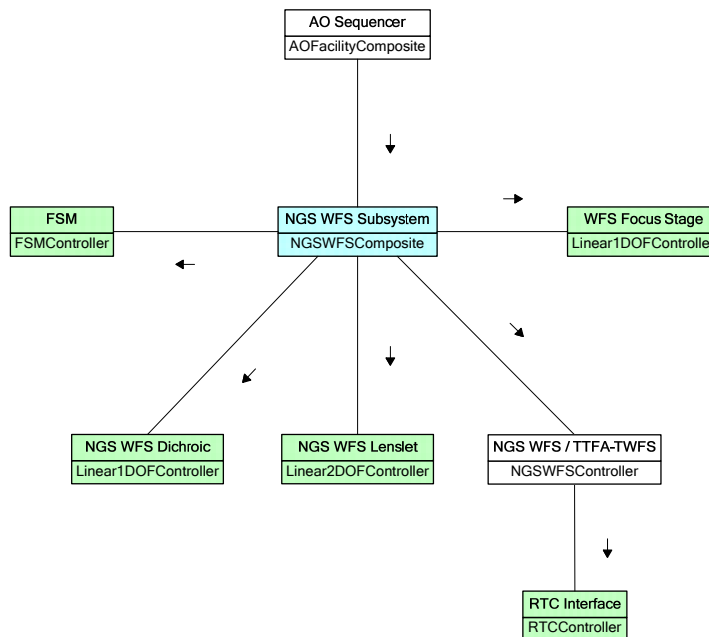

The NGS WFS is under the direct control of the real-time system. The NGAO controls system is responsible for the initialization and configuration of the sensor, and commanding RTC to open and close the WFS control loops. The other NGS devices are all under the direct control of the Controls System. Outside of the RTC NGS control loops, the NGS Subsystem does not implement any tracking or offload tasks. The majority of device control is performed during configuration and acquisition.

5.7.2 Interfaces

The following sections detail the input and output interface to the NGS WFS Subsystem.



5.7.2.1 **Inputs**

The primary inputs to the NGS WFS Composite are implemented as KCSF actions. Actions are defined through an attribute list and may contain parameters. The following define all of the recognized actions available to the NGS WFS Composite.

Home

The *Home* action is responsible for connecting to the hardware and NGAO components; powering on devices; and performing home sequences. The home sequence will cause the motion control devices to find their home switch and reset their device position to zero. All motion afterward will be relative to the home position.

Initialize

The *Initialize* action is responsible for preparing the NGS WFS Composite subsystem for observing. This involves refreshing network and telemetry connections and returning to the home position.

SetMode

The *SetMode* action is responsible for configuring the NGS Subsystem for a particular observing mode. The NGS hardware is used for all NGS observing modes and LGS with the interferometer. In LGS IF mode (fixed-field and fixed-pupil) the NGS WFS switches into a TTFA / TWFS mode to provide focus information to the LGS WFS focus stage. For all active NGS WFS modes the dichroic beamsplitter will be inserted on-beam. In LGS with an instrument the dichroic will be removed. The NGS subsystem is not used during LGS observing with an instrument, and will be disabled.

The system must be configured each time the observing mode changes, and must be performed prior to target acquisition and observing.

Focus

The *Focus* action is responsible for determining and applying the required focus compensation for the NGS WFS sensor conjugate to the science instrument focal plane. The actual focus position is based on the optics in the science path, and the properties of the science instrument. For any hardware / system configuration change (such as inserting or removing optics, filters, etc.) the NGS WFS focus should be recalculated and applied.

Acquire

The *Acquire* action is responsible for positioning the field steering mirrors to acquire the specified NGS target. The *Acquire* action accepts a set of coordinates for a target in the field, and will compute the relative position of the target with respect to the optical axis. This information will be sent to the FSM to position the target on the WFS. After peak-up the RTC control loops will be closed on the target.

Zero

The *Zero* action removes any offset applied to the FSMs through the *Offset* attribute. The *Zero* action can be executed from any state.

Halt

The *Halt* action is responsible for opening the RTC control loop and taking the controller out of the TRACK state. *Halt* can be issued from any of the post-initialization states.

Recover

The *Recover* action is a state dependent process that is responsible for recovering the NGS WFS Controller in the event of a fault. During observing if the sensor enters a fault state observing may be interrupted. Rather than requiring a full subsystem initialization to clear the fault – consequently ending the science sequence – a recover can be issued, which will selectively reinitialize the faulted device. If the fault can be



cleared the device will be put back into its previous state prior to the fault, and observing should be able to continue, uninterrupted.

Disable

The *Disable* action will power down the device and put the software controller into an idle (low network / resource usage) state. Disable is typically performed at the end of a nights observing or when the device is no longer need, for example when switching to NGS mode. While DISABLED the controller will not be publishing telemetry nor monitoring and responding to system events. A *Home* must be performed to re-enable the device and controller for use. Disable can only be performed when the controller is in a halted state.

5.7.2.2 Outputs

5.7.3 Control Loops

The NGS WFS subsystem does not directly manage any tracking control loops.

5.7.4 Devices

The following details all of the devices managed by the NGS WFS subsystem.

5.7.4.1 Dichroic

The NGS dichroic is a simple linear 1-DOF device that is responsible for splitting the NGS WFS visible light from the science field to the sensor. During NGS and LGS inteferometry the dichroic will be on-beam. For LGS with an instrument the WFS is not used, and the dichroic will be positioned off-beam.

5.7.4.2 Focus Stage

The NGS focus stage is a linear 1-DOF device that is responsible for maintaining the focus of the NGS WFS. The focus of the WFS is based on the properties of the system and instrument. Once the system is configured the focus should not have to be updated. If any new optics are inserted or removed from the beam path, or the instrument properties are changed, the focus may have to be recalculated.

5.7.4.3 Field Steering Mirrors

The field steering mirrors are a pair of coordinate 2-DOF tip-tilt fold mirrors designed to shift the field to change the apparent view of the WFS NGS. This is the reverse concept of using a pickoff arm to select a point in the field: instead you move the field to acquire the target on the WFS. The FSMs will be able to shift the field ± 20 arcseconds to acquire any target in the science field.

5.7.4.4 Lenslet Array

The lenslet array is a linear 2-DOF device used in producing Shack-Hartmann wavefront calculations. This WFS system allows the RTC to determine focus, tip-tilt, and astigmatism for the natural guide stars. The lenslet array will be positioned based on pre-observing calibration tests determined to produce an optimal flat wavefront, with minimal focus and tip-tilt errors.



5.7.4.5 NGS WFS

The NGS WFS is implemented by the *NGSWFSController* and provides an interface to the RTC NGS wavefront sensor. The controller provides all of the functionality necessary to initialize, configure, and acquire the WFS. The NGS WFS Composite will be responsible for managing the NGS WFS controller during regular observing.



5.8 Atmospheric Dispersion Corrector

5.8.1 Description

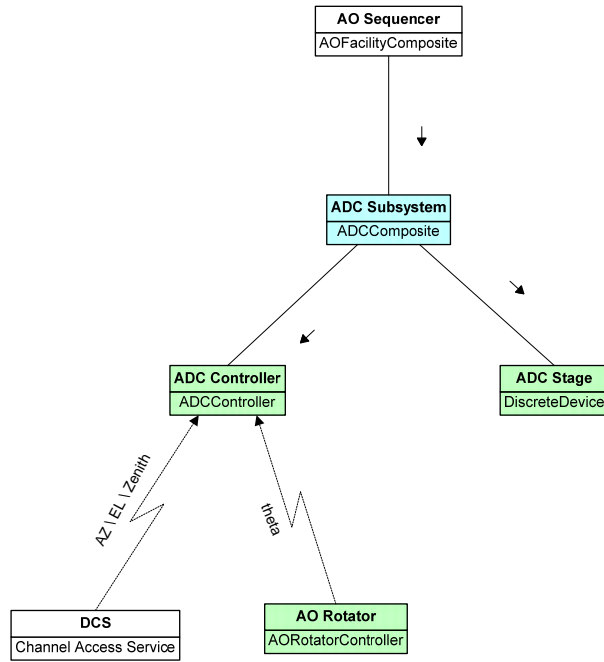

5.8.2 Interfaces

The following sections detail the input and output interface to the ADC subsystem controller.

5.8.2.1 Inputs

The primary inputs to the ADC composite are implemented as KCSF actions. Actions are defined through an attribute list and may contain parameters. The following define all of the recognized actions available to the ADC composite.

5.8.2.2 Outputs

5.8.3 Control Loops

5.8.4 Devices



5.8.4.1 ADC Stage

5.8.4.2 ADC



5.9 RTC Interface

5.9.1 Description

5.9.2 Interfaces

5.9.2.1 Inputs

5.9.2.2 Outputs

5.9.3 Control Loops

5.9.4 Devices



5.10 External Offloading

A block diagram for the Acquisition, Guiding, and Pointing Control function is shown below in Figure 14. The control consists of two main functions: acquisition and guiding, and pointing control. The pointing control function implements the three types of offloading required, coma offloading, tip-tilt offloading, and focus offloading, as well as offset and loop control. Each of these functions is discussed in further detail below. The functions shown below will be implemented in some combination of hard-real-time and soft-real-time control applications. A key task during the PD phase will be to further define these functions and their host CPUs in coordination with the Science Operations team (see KAON 567: NGS and LGS Acquisition Subsystems for NGAO: Initial Requirements and Conceptual Design).

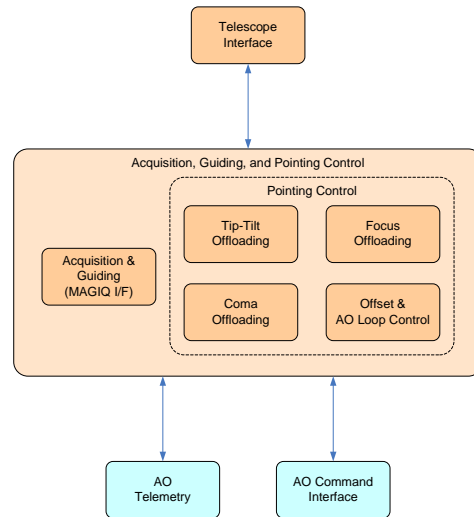

Figure 14: A block diagram of the acquisition, guiding and pointing control software architecture.

5.10.1.1 Acquisition and guiding

The acquisition and guiding control block is the interface between the AO system and MAGIQ guider. It represents the hardware and software “glue” required to connect the acquisition camera to the MAGIQ guider system used at the observatory. Some upgrades to the MAGIQ system may be required to support all of the NGAO acquisition requirements.

5.10.1.2 Pointing control

The pointing control function is the interface between the AO system and the pointing functions of the telescope. This includes pointing offsets for tip-tilt and coma offloading, secondary offsets for focus and coma offloading, and an offset control that interfaces to the AO loop commands to control the AO system during telescope offsets and dithers. The offload functions take the appropriate AO telemetry as inputs and compute the required pointing and secondary offsets.

5.10.2 Description

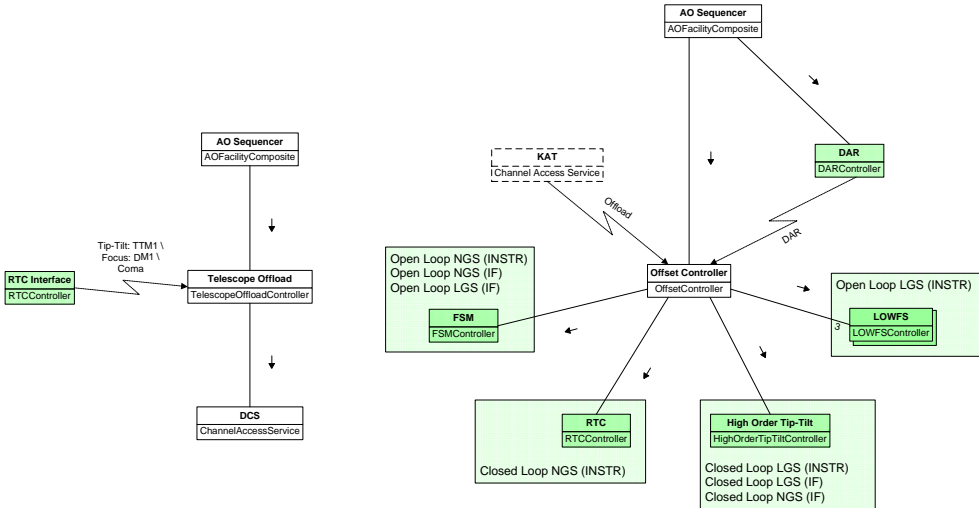

5.10.3 Interfaces

5.10.3.1 Inputs

5.10.3.2 Outputs

5.10.4 Control Loops

5.10.4.1 Telescope Offload

5.10.4.2 Tip-Tilt Offsets

5.10.5 Devices

Although the offload control subsystems communicate with a number of devices they do not actively manage their life-cycle or state. See the relevant subsystems for more information about the offload devices.

- [NGS FSM](#)
- [High-Order Relay](#)
- [LOWFS](#)



5.11 Calibration Simulation

5.11.1 Description

5.11.2 Interfaces

5.11.2.1 Inputs

5.11.2.2 Outputs

5.11.3 Control Loops

5.11.4 Devices



5.12 AO Enclosures

5.12.1 Description

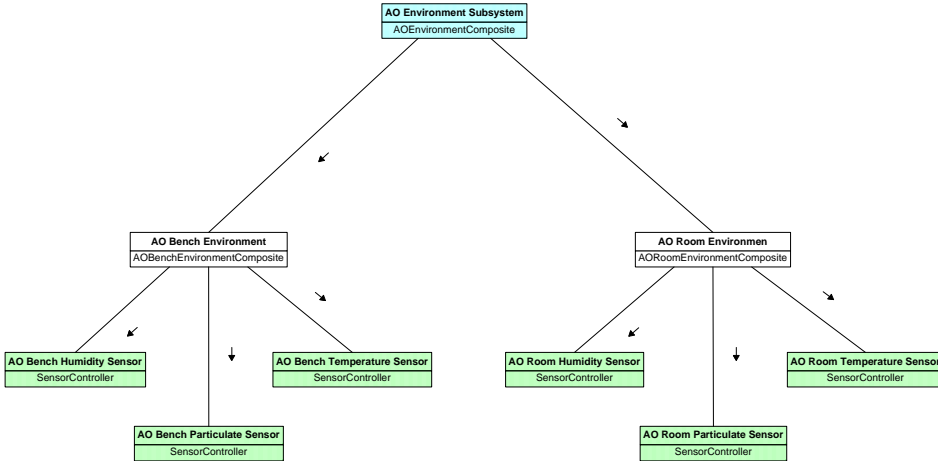

5.12.2 Interfaces

5.12.2.1 Inputs

5.12.2.2 Outputs

5.12.3 Control Loops

As the AO Environment Subsystem is outside of the NGAO control system, and does not manage or interact with any motion control devices, no control loops are implemented.

5.12.4 Devices

5.12.4.1 Temperature Sensor

5.12.4.2 Humidity Sensor

5.12.4.3 Particulate Sensor



5.13 AO Control Sequencer

The AO sequencer, as mentioned above, is the main interface between the various AO controls functions and the rest of the NGAO system. The sequencer has four main components: a command interface, a set of coordination sequences, a data interface and a system health monitor.

5.13.1 Description

5.13.2 Interfaces

5.13.2.1 Inputs

5.13.2.2 Outputs

5.13.3 Control Loops

5.13.4 Devices

5.13.4.1 Temperature Sensor

5.13.4.2 Humidity Sensor

5.13.4.3 Particulate Sensor



6 Laser System

6.1 Introduction

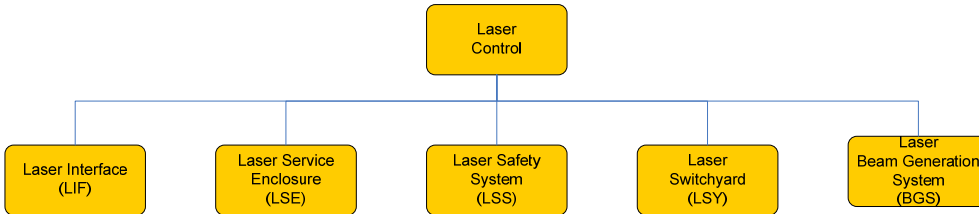

Figure 5 Laser Control Block Diagram

6.2 Laser Switchyard

The NGAO laser system is designed for center mounted propagation, with the laser asterism launched from the back of the telescope secondary. As there are size and weight restrictions on the secondary socket, the actual generation of the lasers will have to be done elsewhere. This will require a system of optics to transport the laser beams from the laser facility to the launch telescope. The transport optics and related hardware are all part of the laser switchyard (the laser units themselves are considered a separate subsystem), and are found in the laser enclosure on the nasmyth platform.

The transport optics consists of tip-tilt mirrors and an associated laser beam positioning sensor. Together the steering mirrors and sensors allow the system to control the path of the lasers as they travel to the secondary. The switchyard also includes a set of polarizers for each laser; a low-power fold mirror that can be used for alignment and acquisition; and the fast safety shutter which is controlled by the Laser Safety Subsystem.

The laser switchyard optics are controlled and managed by the Laser Switchyard Subsystem.

6.2.1 Description

The Laser Switchyard control system is implemented by the *LaserSwitchyardComposite*. This component is responsible for controlling the individual devices and distributed software controllers that implement the switchyard functionality. This includes the low-power fold mirror, steering mirrors, beam polarizers, and beam positioning sensors.

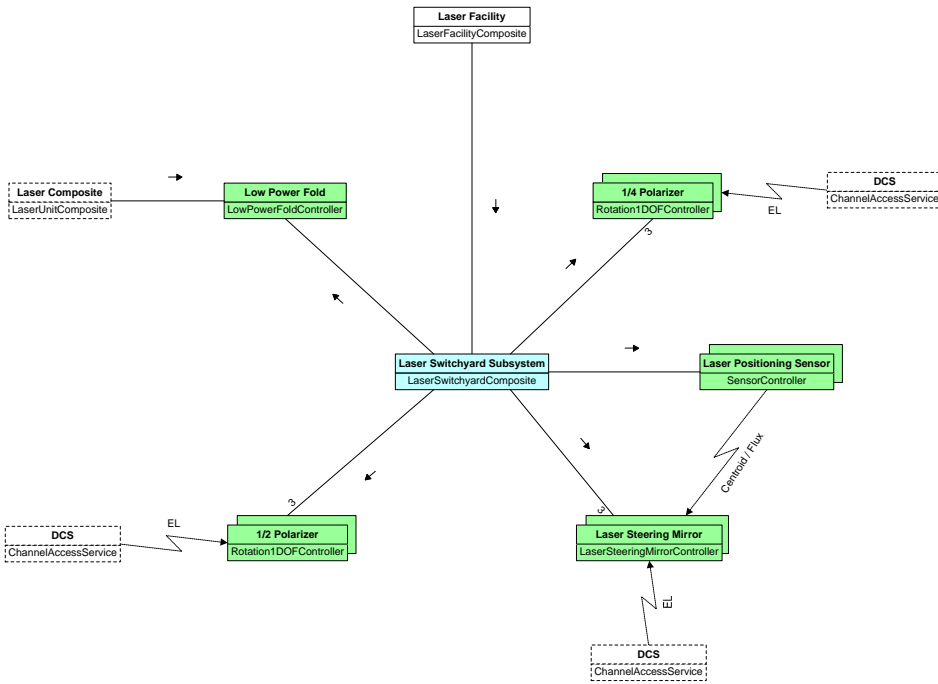

The Switchyard Composite is managed directly by the Laser Facility Composite, and presents a simple high-level interface to initialize, configure, acquire, and disable the switchyard devices. The Composite's primary responsibility is to prepare the switchyard devices for closed loop observing. The majority of the Switchyard Composite functionality exists as part of the configuration and acquisition sequence. During observing the tracking components are independently controlled or run closed-loop with the rest of the system.

The Laser Switchyard Subsystem implements a total of nine tracking control loops: one for each of the quarter and half polarizers, and for each laser steering mirror. The half and quarter polarizer controllers track the required polarization of the laser as a function of the telescope elevation. The Laser Steering Mirror Controllers are responsible for maintaining beam alignment with the BGS, and track with a combination of the telescope elevation and centroid information from the positioning sensors.

6.2.2 Interfaces

The following sections detail the input and output interface to the Switchyard subsystem controller.

6.2.2.1 Inputs

The primary inputs to the Laser Switchyard composite are implemented as KCSF actions. Actions are defined through an attribute list and may contain parameters. The following define all of the recognized actions available to the Switchyard composite.

Home

Initialize



The *Initialize* action is responsible for initializing the Switchyard Composite and controllers.

SetMode

The *SetMode* action is responsible for configuring the Laser Switchyard composite and subcomponents for a particular observing mode. Mode configuration will enable / disable and reposition devices as required by the observing use cases.

Fixed field and fixed pupil modes only differ in the use of the wide field LGS beamtrain. In fixed pupil observing the point and shoot LGS beacons are not used and the PnS laser unit is shuttered. The PnS laser polarizers (half and quarter) can be disabled to reduce resource usage. For safety reasons however the associated laser steering mirror and beam positioning sensor must remain active. (If the laser was to be accidentally opened we wouldn't want the laser to be sent off into hardware.)

In fixed field mode up to three wide field beacons will be managed. The PnS laser unit, switchyard hardware, and transport optics must all be enabled and tracking.

Mode configuration is performed internally by each component. The specific configuration details are hidden from view of the other control system components. This allows each system component to configure its self, without requiring higher level controllers to understand the characteristics of a subcomponent. The Switchyard Composite can simply forward the target mode configuration to each of its components and be confident they will configure correctly.

The system must be configured each time the observing mode changes, and must be performed prior to target acquisition and observing.

Acquire

The *Acquire* action is responsible for commanding the laser switchyard components to prepare the switchyard for laser propagation and transport.

This action has the following effect on the switchyard devices:

- Track the active laser steering mirrors.
- Track the active $\frac{1}{4}$ polarizers.
- Track the active $\frac{1}{2}$ polarizers.

The composite will wait for each device to complete the acquisition process. The collective result of the acquisition process will be returned by the action.

Zero

The *Zero* action is designed to remove any offset applied to the steering mirror or laser polarizers. This action can be executed at anytime post initialization.

LowPower

The *LowPower* action is responsible for configuring the switchyard system for low power laser propagation. This is performed by inserting the Low-Power fold mirror into the laser beampath redirecting 99.9% of the laser light to a dump: allowing the leakage to continue through the system. As a requirement, the Laser shutters must be closed before the fold can be inserted. If the lasers are not shuttered the action will fail. This validation step is performed by the Low Power Fold Controller.

HighPower

The *HighPower* action is responsible for configuring the switchyard system for high power laser propagation. This is performed by removing the Low-Power fold mirror from the laser beampath allowing the laser to propagate at full strength. As a requirement, the Laser shutters must be closed before the fold can be removed. If the lasers are not shuttered the action will fail. This validation step is performed by the Low Power Fold Controller.



Halt

The *Halt* action is responsible for halting device motion and opening the tracking loops. This action will cause the laser steering mirrors, polarizers and beam positioning sensors to all enter their *HALT* state. As these devices are no longer tracking, flexure compensation will not be performed. If the switchyard is not tracking the laser units or safety shutter should be closed.

Recover

The *Recover* action is responsible for selectively initializing faulted sensors devices by Laser Switchyard Subsystem. When the subsystem receives the recover action it will send a recover command to each of the switchyard controllers. If any of the controllers are faulted they will attempt an initialization, and clear the fault if the device reports the initialization was successful. . If the recover is successful the switchyard composite will clear its own fault state. The recover action can be issued at any time, and will not affect healthy components.

Disable

The *Disable* action is responsible for putting the Switchyard composite in a low-power, low-resource state.

6.2.2.2 Outputs

6.2.3 Control Loops

The following sections detail the tracking and offload control loops of the Switchyard subsystem. Each control loop is implemented in part of in full by one or more of the switchyard subsystem controllers.

6.2.3.1 Laser Transport

The laser transport control loop is responsible for maintaining the proper alignment of the lasers from the laser enclosure to the BGS. This control loop is needed to compensate for flexure as the telescope tracks a target; and uses a combination of the telescope elevation and feedback from the beam positioning sensors to calculate the appropriate position of the laser steering mirrors.

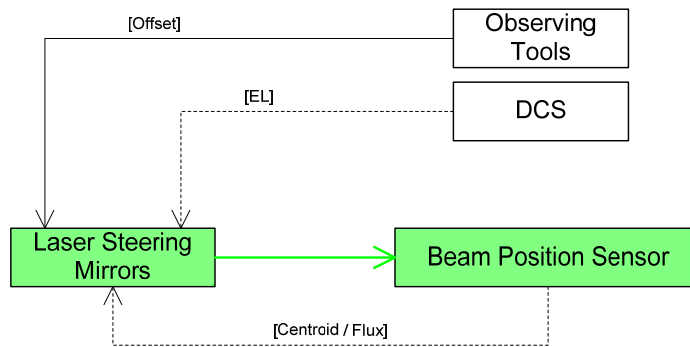

Although the laser transport tracking loop (implemented by the Laser Steering Mirror controller) uses inputs from DCS and the positioning sensors, it does not use both of them at the same time. The laser facility can propagate the lasers in high-power and low-power modes, depending on the position of the low-power fold mirror. When the fold mirror is in the beam path, all but a small percentage of the laser light is diverted to a beam dump. The leakage is allowed to propagate through the system and can be used for



alignment and tests with little risk to hardware or personnel. When the fold mirror is retracted the full beam is allowed to propagate.

The laser transport control loop will use the flux value from the beam positioning sensors to determine if the system is configured for low or high-power propagation. If the flux is below a certain threshold the control loop will use the current telescope elevation from DCS. The elevation will be used to index a simple table to determine the appropriate flexure compensation to apply to the steering mirrors. These values will have been derived from tests empirical tests and will be interpolated to find the appropriate tip-tilt to apply to the stage.

If the positioning sensor threshold reports sufficient laser light centroid information will be obtained from the detector and will be used to calculate the precise compensation required to keep the laser aligned with the BGS.

In either low or high-power track mode the operator can apply an offset to the steering mirrors to redefine the ideal centroid position. The Laser Steering Mirror tracking loop should be closed whenever the lasers are propagating.

6.2.3.2 Laser Polarization

During observing the laser asterism needs to have the proper polarization to be seen by the AO wavefront sensors. Fortunately this polarization is directly related to the elevation of the telescope and incidence angle of the laser with the sodium layer. The control loop to maintain the desired polarization is implemented by each of the polarizer controllers.

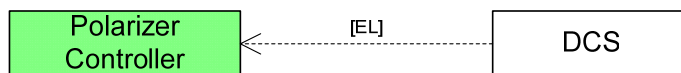

The polarizer controller tracking loop is event driven and responds to telescope elevation events from DCS. When an EPICS event is received the controller will lookup the required orientation of the polarizer in a table based on the current elevation. The table will be defined through empirical tests at regular telescope elevations. The actual polarizer orientation will be interpolated based on these values.

The Half and Quarter Polarizer tracking loop can be remain closed throughout a night's observing.

6.2.4 Devices

The following devices are managed by the Laser Switchyard subsystem, and are listed in the order the laser light propagates through the switchyard. Specific details, interfaces, and discussions are available in their related design documents.

6.2.4.1 Half & Quarter Polarizers

Each laser unit has a dedicated half and quarter polarizing lens. The polarizers are responsible for maintaining the proper polarization of the lasers for observing. The required polarization is based on the angle of incidence of the lasers and the sodium layer, which can derived from the current telescope elevation.

6.2.4.2 Low-Power Fold Mirror

The low-power fold mirror is designed to redirect all but a small fraction of the laser light into a cold dump. The leakage from the mirror is allowed to propagate through the system to the BGS. At this power level the



laser light can not cause any damage to the system during alignment, calibration or testing. The low-power fold mirror is common for all three laser beams.

6.2.4.3 Laser Steering Mirrors

There are a total of three tip-tilt laser steering mirrors – one for each laser – responsible for propagating the lasers from the switchyard to the BGS. The steering mirrors will compensate for flexure as the telescope moves by using pre-measured flexure values, and feedback from beam positioning sensors on the BGS.

6.2.4.4 Beam Position Sensors

The three beam positioning sensors work closed loop with the laser steering mirrors to correct for telescope flexure. As the telescope changes in elevation the gravity vectors will exert forces on the telescope structure causing flexure. The sensors will see this as a change in the beam position for which the laser steering mirrors will then compensate.



6.3 Laser Beam Generation System

NGAO is a multi-laser adaptive optics system designed to correct for atmospheric turbulence over a large area. As part of the science requirements of the system, a constellation of lasers will need to be produced and positioned on sky to perform tomography on the seeing column. In addition, up to three wide-field natural guide stars may also be used to provide full-field tip-tilt and focus correction.

To satisfy these requirements the laser system will make use of four fixed laser guide star (LGS) beacons for tomography, and three roaming LGS beacons to individually sharpen the wide-field tip-tilt stars. The entire laser constellation must be flexible enough to be positioned and orientated anywhere in the field of regard, and must be able to achieve any wide-field tip-tilt configuration.

All of the hardware needed to produce this laser asterism are part of the laser beam generation system (BGS), and is located on the back of the telescope secondary mirror. The BGS is controlled and managed by the Laser Beam Generation Subsystem.

6.3.1 Description

The *BeamGenerationSystemComposite* is a high-level multi-device manager that is responsible for acquiring and configuring the hardware on the BGS. These devices include the point-and-shoot steering arms, beam splitters, asterism rotator, tip-tilt mirror, and beam expander focus.

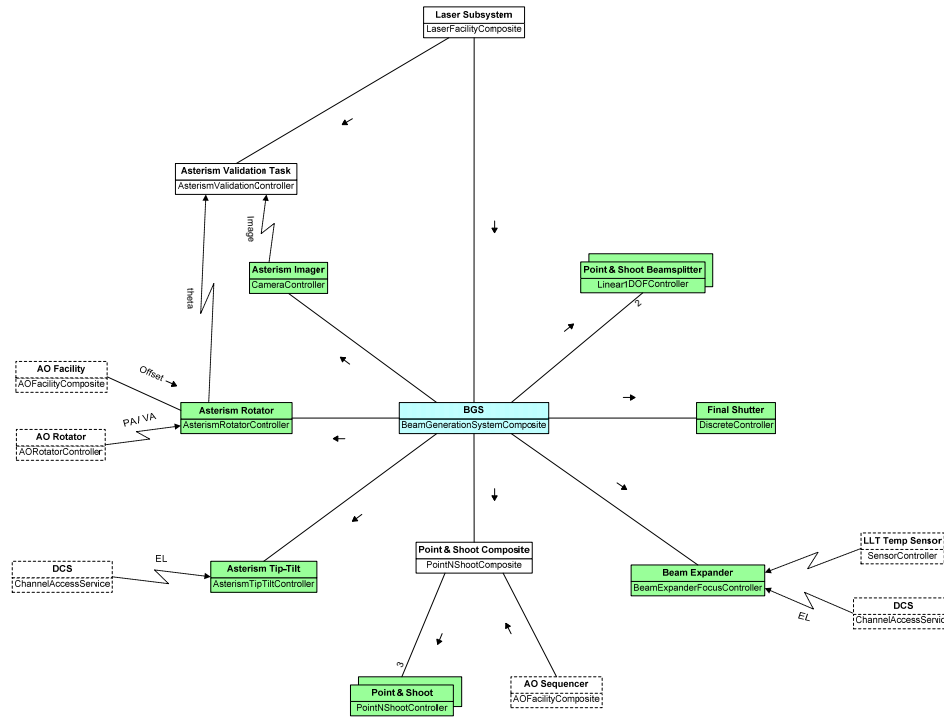

The BGS Composite is managed directly by the Laser Facility Composite, and presents a simple high-level interface to initialize, configure, acquire, and disable the BGS devices. The majority of the BGS Composite



functionality exists as part of the configuration and acquisition sequence. During observing the majority of the subcomponents are independently controlled or run closed-loop with the rest of the system.

The BGS subsystem is responsible for configuring and positioning the hardware to obtain the desired laser constellation. The constellation is based on the number and position of the wide-field targets, the position of the telescope, and the desired image orientation as seen from the science detector. The BGS subsystem will take this information and calculate the required positions for each of the associated devices.

The BGS subsystem also manages the focus and propagation of the lasers and implements safety processes to validate the health of the laser generation system. Before the lasers can be propagated on sky a validation is performed to ensure the proper structure of the laser asterism. This step is performed periodically throughout observing and is used to verify that the lasers are working properly and are not at risk of causing damage to the system or personnel.

The following sections detail the BGS subsystem and devices.

6.3.2 Interfaces

The following sections detail the input and output interface to the BGS subsystem controller.

6.3.2.1 Inputs

The primary inputs to the BGS composite are implemented as KCSF actions. Actions are defined through an attribute list and may contain parameters. The following define all of the recognized actions available to the BGS composite.

Home

The *Home* action is responsible for homing the BGS Composite and subcontrollers. On completion all of the devices on the BGS should be properly homed and encoders zeroed.

Initialize

The *Initialize* action is responsible for initializing the BGS Composite and controllers.

SetMode

The *SetMode* action is responsible for configuring the BGS software controllers and devices for a particular observing mode. BGS mode configuration will enable / disable and reposition devices as required by the observing mode. The following actions are taken for LGS observing:

Fixed-Field LGS

- Enables all BGS controllers.
- Configures Asterism Rotator for fixed-field (parallactic angle) tracking.

Fixed-Pupil LGS

- Disables Laser Beam Splitter Controllers and Point-and-Shoot Composite.
- Configures Asterism Rotator for fixed-pupil (vertical angle) tracking.

The system must be configured each time the observing mode changes, and must be performed prior to target acquisition.

Acquire

The *Acquire* action performs the target acquisition of the BGS system. This action requires the pointing target for the telescope (including any telescope offsets) and up to three LGS targets, all in sky coordinates: the target coordinates will be used to position the point-and-shoot laser beacons. The BGS Composite will calculate the offsets of the three targets relative to the optical axis in arcseconds, and command the Point-



and-Shoot Composite to acquire the targets. The number of LGS targets will also be used to determine the appropriate configuration for the PnS Beam Splitters.

The Acquire action is also responsible for putting the BGS devices into the proper state for observing:

- Asterism Tip-Tilt Controller is put into TRACK.
- Asterism Rotator is put into TRACK.
- Asterism Imager Controller is put into free-run mode.
- Beam Expander Focus Controller is put into TRACK.

If any of the devices fail to enter their required states, or there is a problem acquiring the wide-field targets, the Acquire action will fail.

Close

The *Close* action commands the BGS Composite to close the final shutter, and halt laser propagation. This action will typically be executed during a configuration mode change and when an observing sequence has been halted.

Open

The *Open* action commands the BGS Composite to open the final shutter and is performed as the last step of laser acquisition and propagation.

Zero

The *Zero* action is responsible for returning the BGS devices to their nominal zero position (this may or may not be true zero as related to range of motion or encoder count). Effectively this is the same as removing any offsets added to the devices during observing or acquisition. This action has the effect of:

- Positioning the Asterism Tip-Tilt mirror to its nominal (flexure compensated) position.
- Return the Asterism Rotator to its nominal (PA / VA defined) position.
- Evenly distributing the Point and Shoot arms in the wide-field area of regard.
- Position the Beam Expander Focus stage to its nominal position.

Since the *Zero* action can cause the point-and-shoot steering arms to perform a large slew, it can not be executed while the lasers are propagating at full power. The laser shutters must be closed, or the low-power fold inserted before the *Zero* action can be executed.

Halt

The *Halt* action is responsible for halting all devices on the BGS and is typically issued to interrupt or terminate a sequence. Any devices currently in motion will be immediately stopped, and all loops will be opened: this includes stopping automated asterism validation (Validation Controller) and taking the asterism imager out of free-run.

Halt can be issued from any of the post-initialization states, and from the HALT state the controller can be reinitialized, disabled, or perform a new acquisition.

Recover

The *Recover* action is responsible for selectively initializing faulted devices managed by the Beam Generation System. When the subsystem receives the recover action it will send a recover command to each of the BGS controllers. If any of the controllers are faulted they will attempt an initialization, and clear the fault if the device reports the initialization was successful. If the recover is successful the BGS will clear its own fault state. The recover action can be issued at any time, and will not affect healthy components.

Disable

The *Disable* action is responsible for putting the BGS devices and controllers in a low-power, low-resource state.



6.3.2.2 Outputs

BGS Composite outputs are made available as KCSF events. Each event is identified by a unique name.

State

The *State* event publishes the current SMC state of the BGS Composite, and is the primary means of conveying the current operating state to the laser facility sequencer.

Health

6.3.3 Control Loops

The following sections detail the tracking and offload control loops of the BGS subsystem. Each control loop is implemented in part or in full by one or more of the NGAO controllers.

6.3.3.1 Focus Tracking

During observing the BGS subsystem will have to track the changing focus of the LGS asterism. Focus is primarily based on the current telescope elevation and air temperature. As the telescope elevation changes the beam length of the laser from the telescope to the sodium laser will fluctuate. As the apparent distance to the sodium layer changes the beam expander will have to compensate to maintain LGS focus. The temperature of the air at the launch telescope also affects the focus of the laser. This information is derived from the environmental sensors within the LLT.

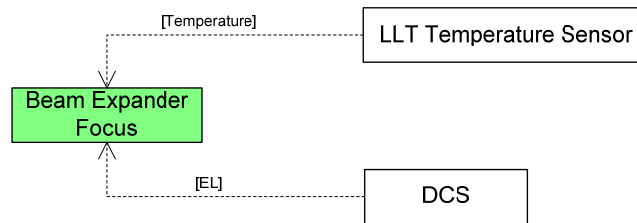

Beam expander tracking is an event driven control loop triggered by telemetry events from the LLT environment sensors and DCS telescope elevation keywords. When the controller receives input from these items it will calculate the LGS asterism focus compensation and apply it to the stage. A lookup table should be sufficient to define focus compensation based on telescope elevation and temperature.

6.3.3.2 Rotator Tracking

During observing the laser asterism will need to track the LGS targets as the telescope rotates. In fixed field mode this is based on the parallactic angle (PA). In fixed pupil mode the rotator will track the vertical angle (VA). In addition, the asterism rotator will need to maintain a consistent orientation in regards to the AO image rotator.

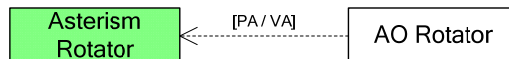



Rotator tracking and offloading is event drive. The Asterism Rotator Controller will receive field and pupil angle information from AO rotator telemetry, as well as any arbitrary changes to the AO rotator orientation. The asterism rotator will process this information and track with telescope and field rotation.

6.3.3.3 Flexure Compensation

Changes in telescope elevation will induce flexure on the BGS and launch optics. As the telescope tracks a target the asterism tip-tilt will need to compensate for flexure to keep the asterism fixed with the targets.

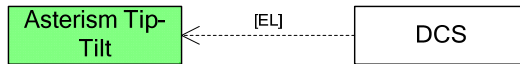

The Asterism Tip-Tilt Controller implements an event driven tracking loop. Primary input to the control loop is the telescope elevation and is made available from DCS through the Channel Access service. A simple look-up table can be used to interpolate the required flexure compensation for the current elevation.

6.3.3.4 Asterism Validation

A key requirement during observing is to ensure the safe propagation of the lasers and the proper structure of the asterism. This safety issue is managed by the Asterism Validation task.

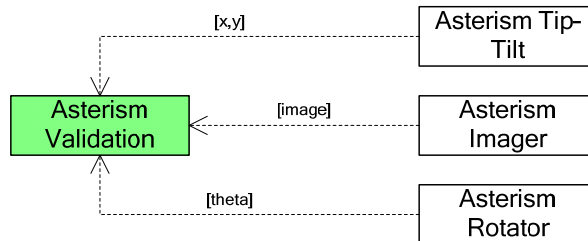

This task is designed to perform asterism validation and error handling during the acquisition and observing sequence. The control loop implements an image processing routine that takes images from the Asterism Imager Camera and compares the laser beacons against their expected positions in the field. These positions are based on the coordinates of the tip-tilt targets, position of the asterism tip-tilt mirror, and the orientation of the rotator. If there are any major changes to the asterism structure, such as the loss of an LGS beacon, the validation controller can take an automated response to ensure the safety of facility.

6.3.4 Devices

The following devices are managed by the BGS subsystem, and are listed in the order the laser light propagates through the BGS. Specific details, interfaces, and discussions are available in their related design documents.

6.3.4.1 Beam Splitter

The BGS subsystem manages two linear 1-DOF beam splitters. These devices are used to split the wide-field LGS laser into the required number of roaming LGS beacons. The beam splitters can be configured to produce one, two, or three beacons: off-beam, one on-beam or both on-beam, respectively. The specific configuration will depend on the number of tip-tilt guide stars used. The beam splitters are controlled through KCSF Linear 1-DOF Controllers.



6.3.4.2 Point & Shoot

The point and shoot steering arms allow the BGS to position the wide-field beacons anywhere in the permitted range of the LGS asterism. There are a total of three point and shoots, each implemented as a linear 2-DOF actuated arm. Each point and shoot can be positioned arbitrarily in the field; with software restrictions preventing them from being within the central asterism and from occluding one another. The three point and shoot steering arms are managed by the Point & Shoot Composite which is responsible for validating target acquisition, preventing collisions between arms, and managing the point and shoot interaction. The point and shoot devices are controlled through the KCSF Linear 2-DOF Controller.

6.3.4.3 Asterism Rotator

The asterism rotator is a rotational 1-DOF K-mirror device responsible for the orientation of the entire laser asterism. The asterism rotator is designed to keep the laser asterism aligned to a specific orientation with respect to the sky (fixed field) or detector (fixed pupil). This tracking device receives inputs from the AO facility as offsets and must maintain a relative orientation to the AO image rotator. The asterism rotator is controlled through the NGAO Asterism Rotator Controller.

6.3.4.4 Asterism Tip-Tilt (up-link)

The asterism tip-tilt mirror is a 2-DOF device that allows the AO controls system to shift the entire laser asterism on the sky. This common mirror is used during the acquisition and observing sequences for LGS WFS alignment and flexure compensation. The tip-tilt mirror will compensate for flexure by tracking the telescope elevation, and any additional offsets issued by the control system. The tip-tilt mirror is controlled through the NGAO Asterism Tip-Tilt Controller.

6.3.4.5 Beam Expander

The beam expander stage is a linear 1-DOF device that is responsible for maintaining the required LGS focus. This tracking device responds to changes in the telescope elevation and the environmental conditions in the LLT. The beam expander focus stage runs in a nearly continuous automated fashion, and is controlled through the NGAO Beam Expander Focus Controller.

6.3.4.6 Asterism Imager

The asterism imager is a slow-rate diagnostic camera that provides a view of the LGS asterism prior to the launch telescope. This camera picks up the leakage from the LLT fold mirror on the BGS, and shows the real-time structure of the asterism after the rotator, tip-tilt and steering arms. The asterism imager camera is controlled through a KCSF Camera Controller and is primarily used by the Asterism Validation task.



6.4 Laser Safety System

The *LaserSafetySystemController* is a subclass of the [Controller](#) definition, and provides an interface to the Laser Safety System (LSS): a subsystem responsible for monitoring the state of the laser system and ensuring safe operating conditions. A number of devices are under the complete control of the safety system, and can not be controlled directly by the software system. In order to offer a level of control to these devices (such as the beam dump and BGS fast shutter) functionality will exist in the safety system to accept control requests. If the requests do not risk the safety of the system or personnel they will be performed.

For the most part the laser Safety System is a self-contained system. The LSS controller provides an interface to a basic set of safety system controls and hardware. The controller will be responsible for providing permissive data to the safety system, and for publishing alarm events detected by the laser safety system.

6.4.1 Description

The control of the laser safety system functions is shown below in Figure 13. This section is not meant to describe the design of the laser safety control system, which is covered in the laser portion of the system design, but the control interface to the laser safety control system. The control interface to the laser system consists of an EPICS device driver to provide an EPICS interface to the system, and possibly some high-level coordination sequences that would be part of the laser sequencer to coordinate sequences of complex safety system commands.

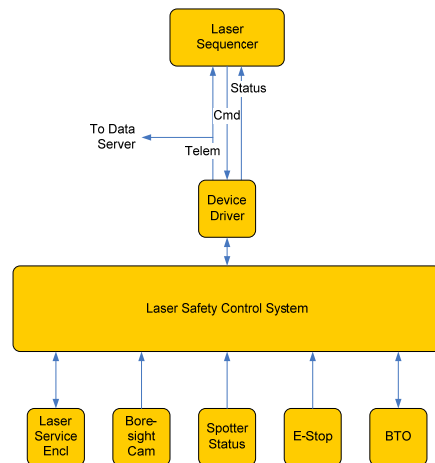

Figure 13: A block diagram of the laser safety system control software architecture.

6.4.2 Interfaces

6.4.2.1 Inputs



Home

Initialize

The *Initialize* action is responsible for preparing the LSS controller for LGS observing. The initialization process will connect to the laser safety system, create monitors and telemetry topics, and launch the safety event handler task. This task is responsible for notifying the rest of the NGAO control system of any errors or warnings that may impact observing, allowing the higher level controllers to respond appropriately (including halting the current sequence). See the [Remarks](#) section for more details.

SetPermissive

The *SetPermissive* action is responsible for setting the state of one or more LSS permissives. This action can only be executed from within the post-initialization states.

A permissive is defined by a string and a boolean value, and can be any one of the recognized names available to the LSS. The permissives include, but are not limited to, the following:

- Observing Assistant Acknowledgement: The final permissive from the OA to permit laser propagation on-sky.
- Laser Traffic Control System: Confirms there is no laser or observing collisions between the other Mauna Kea observatories.
- Spotter Acknowledgment: Confirmation from the spotters that it is safe to propagate.
- Telescope Control Acknowledgement: Confirmation that the telescope is tracking and in the safe telescope elevation window for laser propagation.
- Satellite Safety Acknowledgment: Confirmation from space traffic control that there are no imminent satellite crossings over the laser path.
- Laser Transport Acknowledgement: Software confirmation that the lasers are being transported to the BGS properly. (This can double for a valid asterism confirmation.)
- Reduced Performance Acknowledgment: Permits (or prevents) the system from running with a reduced set of laser units. This may be needed in the event that one of the lasers is malfunctioning, but observing should continue.

These permissives cover the majority of system state properties that are not directly visible by the Laser Safety System. The full set of software supplied permissives will be finalized after the laser vendor has been chosen.

Close

Closes the shutter specified in the attribute *shutter*. This can be any of the subordinate shutters that comprise the laser safety system, and are specified by a partial or fully qualified KCSF name. The actual shutter name will depend on the values set in configuration but cover the Beam Dump and BGS Fast Shutter.

Open

Opens the shutter specified in the attribute *shutter*. This can be any of the subordinate shutters that comprise the laser safety system, and are specified by a partial or fully qualified KCSF name. The actual shutter name will depend on the values set in configuration but cover the Beam Dump and BGS Fast Shutter.

FullStop

This action tells the Laser safety System that it should immediately put the system into an emergency safe state. This includes closing shutters, powering down lasers, and taking any additional full-stop safety precautions.

Acknowledge



The *Acknowledge* action is used to force the LSS Controller out of an alarm state by acknowledging the existence of an alarm condition. Ideally alarm conditions will be satisfied by either correcting the problem identified by the LSS or setting the appropriate permissives. This should then cause the LSS Controller to return to the READY state. In the case where the problem can not be immediately handled and observing is to continue the acknowledge action can confirm receipt of problem, and put the controller back in the READY state allowing it to respond to other alarm conditions that may occur.

Note: the acknowledge action does not change the state of the LSS, it simply silences the current alarm state from within the NGAO control system. If the LSS issues the same error condition again it will result in reentrance of the ALARM state.

Halt

The *Halt* action is responsible for putting the LSS Controller into the *HALT* state. As the LSS Controller does not have any motion control requirements this action is implemented as a no-op routine, and exists primarily for consistency with the NGAO Controller design.

Recover

...

Disable

The *Disable* action will cause the controller to suspend the event handler task and enter a low resource usage state. While *DISABLED* the controller will not be able to notify the higher level sequencer of safety events or be able to set permissives for the laser safety system.

This action should only need to be executed during shutdown of the NGAO control system, and can only be executed from the *HALT* state. The controller can be reinitialized and safety event handler restarted by performing a *Home*.

6.4.2.2 Outputs

6.4.3 Control Loops

6.4.4 Devices

The following devices are managed by the Laser Safety Subsystem. Specific details, interfaces, and discussions are available in their related design documents.

6.4.4.1 Laser Safety System



6.5 Laser Service Enclosure

6.5.1 *Description*

The *LaserEnclosureComposite* manages the environmental sensors found in the laser unit enclosure. These sensors are responsible for providing the current temperature, humidity, and particulate level.

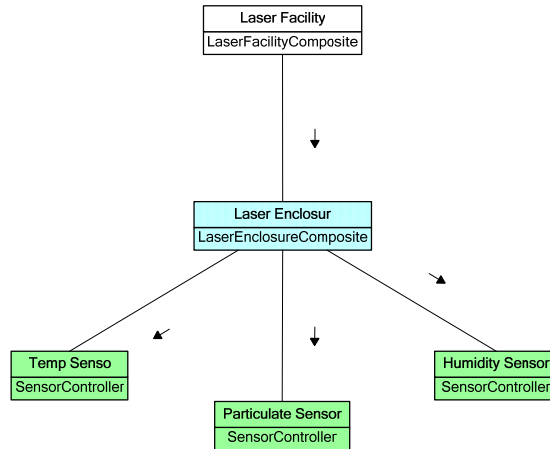

As sensors are simple on / off devices without motion control requirements, the composite itself is very simple, and provides the basic capabilities to initialize the system for observing. The composite will collect data from each of its sensors and will provide a summarized health status as telemetry and alarming.

6.5.2 *Interfaces*

6.5.2.1 *Inputs*

Home

Initialize

The *Initialize* action is responsible for initializing the Laser Enclosure Composite and controllers. As part of the initialization process the composite will create all of its telemetry topics and refresh connections to subordinate controllers. The Initialize action will cascade down to each of the sub-controllers, which will in turn prepare the devices for use. (See the [subordinate controllers](#) for more information).

Halt

As there are no motion control requirements for the Laser Enclosure Composite the *Halt* actions exists primarily for consistency with the NGAO composite design pattern. The halt action is effectively a no-op routine, and can be issued from the INIT or READY states. The halt action is required prior to disabling and shutting down the composite and sensor controllers.

Recover



The *Recover* action is responsible for selectively initializing faulted sensors managed by the Laser Service Enclosure. When the subsystem receives the recover action it will send a recover command to each of the sensor controllers. If any of the controllers are faulted they will attempt an initialization, and clear the fault if the device reports the initialization was successful. The recover action can be issued at any time, and will not affect healthy components.

Disable

The *Disable* action is responsible for putting the laser enclosure composite in a low-power, low-resource state. Disable is typically performed at the end of a nights observing or when monitoring of the laser enclosure is no longer need, for example when the lasers are powered down. While DISABLED the Laser Enclosure Composite and sensors will not be publishing telemetry nor monitoring and responding to system events. A *Home* must be performed to re-enable the composite and controllers for use. Disable can only be performed when the controller is in the HALT state.

6.5.2.2 Outputs

6.5.3 Control Loops

As the Laser Enclosure subsystem does not manage any motion control devices, and the environmental information of the laser enclosure is not used in a controls context, this subsystem does not implement any control loops.

6.5.4 Devices

The following devices are managed by the Laser Enclosure subsystem. Specific details, interfaces, and discussions are available in their related design documents.

6.5.4.1 Environmental Sensors

The Laser Enclosure subsystem manages the temperature, humidity, and particulate sensors found in the laser enclosure. These sensors run continually, even outside of the regular NGAO control system, and provide environmental information to the operators through the observing tools. Although not used in a direct controls context, the environmental sensors will report excessive environmental conditions to the NGAO alarm system, allowing the operator to take action if needed.



6.6 Laser Interface

The NGAO laser system is designed to produce up to seven laser beacons using three laser sources. Two of the laser units are responsible for producing the central asterism of four beacons (each split 50 / 50). The third laser unit is responsible for producing the three wide-field PnS beacons (split 33 / 33 / 33). Depending on the observing mode all three lasers may be used, just the central asterism lasers, or no lasers (NGS observing). The laser units are all managed under the Laser Interface Subsystem.

6.6.1 Description

The Laser Interface Subsystem is implemented by the *LaserUnitComposite*, and manages the three laser units. Although the lasers are under the direct control of the LSS, separate NGAO components will be created to interface with each laser units, providing a more intuitive and convenient method of distributed control.

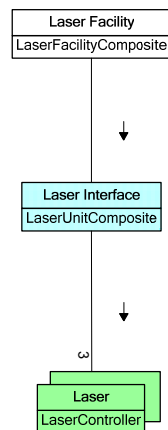

Above the *LaserControllers* will be the laser interface subsystem. This composite provides a single unified command and status interface to the lasers. Clients can treat the laser sources as a single instance, allowing them to issue a single command in place of three. Additionally, health and status information for all three laser units will be consolidated and made available to the control system for easy reference.

The Laser Unit Composite is managed directly by the Laser Facility Composite.

6.6.2 Interfaces

6.6.2.1 Inputs

Home

The *Home* action is responsible for preparing the laser units for observing, specifically initiating laser calibration. The *LaserUnitComposite* will stay in the *HOME* state until the laser calibrations and warm-up have completed.

Initialize



The *Initialize* action is responsible for closing the laser shutters and putting the software composite into the in-position state.

SetMode

The *SetMode* action is responsible for configuring the Laser Switchyard composite and subcomponents for a particular observing mode. Mode configuration will enable / disable and reposition devices as required by the observing use cases.

Fixed field and fixed pupil modes only differ in the use of the wide field LGS beamtrain. In fixed pupil observing the point and shoot beam train is not used, and the PnS laser unit can be disabled. In fixed field mode the wide-field beacons are available, and all three laser units are enabled and initialized for use.

The system must be configured each time the observing mode changes, and must be performed prior to target acquisition and observing.

Close

The *Close* action is responsible for shuttering the active laser units. While shuttered no laser light will enter the beam train.

Open

The *Open* action is responsible for opening the active laser unit shutters. While open the laser light will propagate through the beam train.

To ensure the safety of the system, this command will fail if any of the transport or alignment devices are not tracking and in position. Specifically all of the following must be true before the laser shutters can be opened:

- Laser Steering Mirrors are tracking
- Beam Splitters are in position.
- Point and Shoot Steering arms in position.

TuneOn

The *TuneOn* action is responsible for tuning the active lasers on to the 589nm wavelength. This must be performed for the AO wavefront sensors to operate properly.

TuneOff

The *TuneOff* action is responsible for tuning the active lasers off of the 589nm wavelength. The actual wavelength will be defined and preset in the unit. This action is performed when taking measurements of the background signal.

Halt

The *Halt* action is responsible for putting the laser units in a halted / safe state. Specifically this action will shutter the laser units to prevent laser propagation. The halt action is required prior to disabling and shutting down the composite and controllers.

Recover

The *Recover* action is responsible for selectively initializing faulted laser devices and controllers managed by the Laser Interface Subsystem. When the subsystem receives the recover action it will send a recover command to each of the laser controllers. If any of the controllers are faulted they will attempt an initialization, and clear the fault if the device reports the initialization was successful. The recover action can be issued at any time, and will not affect healthy components.

Disable



The *Disable* action is responsible for disabling the Laser Controller. While disabled network and resource usage will be at a minimum. The laser unit itself will be shuttered, but its state will remain operational and ready for use. The controller must be re-homed before the laser can be used again.

6.6.2.2 Outputs

ShutterState

This attribute returns the current global shutter state of the active laser units. If the active laser shutters are in different states *Open* will be returned.

TuneState

This attribute returns the current global tuned state of the active lasers. If the active lasers are in different states *Off* will be returned.

6.6.3 Control Loops

The Laser Subsystem does not implement any control loops.

6.6.4 Devices

The following devices are managed by the Laser Interface subsystem. Specific details, interfaces, and discussions are available in their related design documents.

6.6.4.1 Lasers

The Laser Interface Subsystem manages the controllers for the three laser units. These controllers provide the capabilities to initialize, calibrate, and propagate the lasers. The controllers themselves do not actually interface directly with the lasers, but acts as a wrapper around the LSS to provide the set of laser commands available to clients.



6.7 Laser Control Sequencer

NGAO can be divided into an up-link (laser) and down-link (AO) system. The up-link system is responsible for producing and propagating the laser asterism on sky. The down-link system is responsible for correcting distortion in the field image caused by atmospheric turbulence. As there is such a clear and distinct functional separation between the two systems each can be modeled with their own control system hierarchy.

At the top of the laser system hierarchy is the Laser Sequencer Subsystem.

6.7.1 Description

The Laser Sequencer Subsystem is implemented by the *LaserFacilityComposite*, and is the highest level component of the laser control system, and is responsible for managing and configuring the entire laser facility. The Composite sits above all of the other laser system components, and coordinates their state and task execution during observing. The Laser Facility is under the direct control of the MSCS.

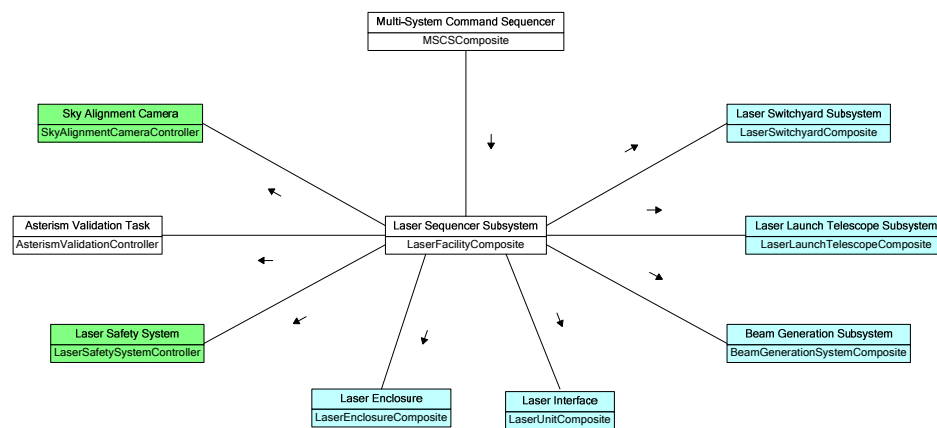

The Laser Sequencer Subsystem exposes a simple set of high level actions to the MSCS. These actions provide the Command Sequencer with the ability to initialize and configure the laser facility; acquire LGS targets; and shutdown the system. The composite in-turn takes the action data and distributes it among the relevant subcomponents; invoking their corresponding initialization, configuration, acquisition, and shutdown actions.

As with other composites, the LaserFacilityComposite will reflect the overall state of its subcomponents: effectively the health and state of the entire laser system. The MSCS will monitor the state of the composite to ensure its continued safe operation, and to respond to any errors that may occur.

6.7.2 Interfaces

The following details the Laser Control Sequencer interface.

6.7.2.1 Inputs



Home

Initialize

SetMode

The *SetMode* action is responsible for configuring the laser facility composite and subcomponents for a particular observing mode. Mode configuration will enable / disable and reposition devices as required by the observing mode.

In fixed-field observing the entire laser facility is enabled and prepared for use. In this mode up to three LGS PnS beacons are used to correct for atmospheric effects on the wide-field tip-tilt and focus stars. As the telescope rotates to track the science target the LGS asterism must also rotate on sky to compensate for the changing parallactic angle. This effectively fixes the laser constellation with the star field as seen from down stream.

In fixed-pupil mode the field is allowed to rotate freely, but the pupil must remain fixed. In this mode the PnS LGS beacons are not used. As a result, the majority of the PnS laser beamtrain can be disabled. To stay fixed will the pupil the laser asterism will only need to match the orientation of the telescope's vertical angle.

Mode configuration is performed internally by each component. The specific configuration details are hidden from view of the other control system components. This allows each system component to configure its self, without requiring higher level controllers to understand the characteristics of a subcomponent. The composite can simply forward the target mode configuration to each of its components and be confident they will be configured correctly.

The system must be configured each time the observing mode changes, and must be performed prior to target acquisition and observing.

Acquire

The *Acquire* action is responsible for commanding the laser facility components to acquire a set of LGS targets. Ultimately the laser asterism will be configured to match a set of sky coordinates based on the orientation of the field and position of the telescope. The acquisition process is typically initiated during the slew to the next pointing target.

This action requires the current pointing information for the telescope and up to three LGS targets, all in sky coordinates. The action arguments will be used to configure and command devices within the laser facility; specifically:

- Prepare for low-power laser propagation
- Select the appropriate PnS Beam Splitter configuration,
- Position the PnS steering arms,
- Track the switchyard devices (steering mirrors and polarizers),
- Track the BGS devices (focus stage, asterism rotator and asterism tip-tilt).

The composite will wait for each device to complete the acquisition process. The collective result of the acquisition process will be returned by the action.

Propagate

The *Propagate* action is responsible for validating the asterism and projecting the high-power laser beams on sky. This action can only be executed when the telescope is tracking, and is typically performed immediately after the slew to the science target.

When initiated, this action will perform a set of steps to validate the asterism before and after switching to high-power laser propagation. If the asterism structure appears correct the final shutter will be opened and



the lasers will be allowed to propagate on sky. Once this action completes the entire laser facility will be properly configured for observing and all tracking loops will be closed.

The combined result of the propagate action will be returned.

Halt

The *Halt* action is responsible for halting all devices in the laser facility, and is typically issued to interrupt or terminate a sequence. Any devices currently in motion will be immediately stopped, and all loops will be opened. The laser facility shutters will be put into a safe state, and propagation will be stopped at the switchyard. Note: as the AO system relies on the laser light to perform atmospheric correction the AO Facility controller must be halted as well. If performed through the observing tools, the MSCS will automatically take care of halting both systems.

Halt can be issued from any of the post-initialization states. From the HALT state the laser facility can be reinitialized, disabled, or perform a new acquisition.

Recover

Disable

The *Disable* action is responsible for putting the laser facility devices and controllers in a low-power, low-resource state. Disable is typically performed at the end of a night's observing or when the laser system is no longer needed, for example when switching to NGS mode. While DISABLED the Laser Facility Composite and sub-controllers will not be publishing telemetry nor monitoring and responding to system events. A *Home* must be performed to re-enable the composite and controllers for use. Disable can only be performed when the controller is in the HALT state.

6.7.2.2 Outputs

6.7.3 Control Loops

The following sections detail the control loops of the Laser Sequencer Subsystem. Each control loop is implemented in part or in full by one or more of the NGAO components.

6.7.3.1 Asterism Validation

NGAO makes use of high-intensity lasers to produce the LGS beacons. If the lasers are not properly aligned they can cause significant damage to the laser facility hardware and injury to personnel. As such, the laser propagation must be periodically validated to ensure the proper alignment and performance of the system. An asynchronous task will be created to monitor the health of the laser system. If the task identifies any major changes to the asterism structure, such as the loss of an LGS beacon, an automated response will be taken to ensure the safety of the laser facility.

The *AsterismValidationController* is designed to perform asterism validation and error handling during the acquisition and observing sequence. This controller subclass implements an image processing routine that takes images from the Asterism Imager Camera and compares the laser beacons against their expected positions in the field. These positions are based on the coordinates of the tip-tilt targets and position of the BGS hardware.

Three failure modes have been identified for the laser asterism and will be monitored by the validation controller. The failure modes are:



- Loss of a laser or beacon – If the asterism validation identifies that there are fewer than the expected LGS beacons in the image the sequence will be halted and the laser system will be put into a shuttered safe state.
- Additional beacons – Potentially the laser system could be configured incorrectly to produce additional beacons when a reduced subset is desired (e.g. fixed-pupil or a single TT target). If the validation task identifies more than the expected number of LGS beacons the sequence will be halted and the laser system will be put into a shuttered safe state.
- Incorrect beacon position – Potentially caused by a number of factors (offloading, flexure compensation, etc.) the laser beacons may drift over time. As all of the beacons are accounted for, only displaced, there is no imminent safety concern for the system. The validation task will assume the system is performing correctly, but will warn the operator that the asterism has changed and that performance could suffer.

The validation task is event driven and will be executed for each new frame produced by the asterism imager camera. The initial positions of the beacons will be calculated when the validation task is started based on the sky position of the tip-tilt targets. The positions of the beacons will be recalculated whenever the BGS rotator or tip-tilt mirror is moved, and should only require a translation and rotation matrix transformation. The validation task is started at the beginning of the science sequence and halted at the end of integrations.

6.7.4 Devices

As a high-level subsystem, the LaserFacilityComposite relies on the low-level subsystems for the majority of hardware control. Although the Laser Sequencer Subsystem is capable of directly interacting with any hardware in the laser facility, there are only a few hardware devices it manages directly. Specific details, interfaces, and discussions are available in their related design documents.

6.7.4.1 Laser Safety System

The Laser Safety System (LSS) acts as a constant supervisory safety controller for the laser system, and must be running at all times the laser units and hardware is active. The LSS monitors a number of system and device states to ensure the system is operating within the defined safe limits. All real-time and safety critical device information is connected directly to the LSS allowing the system to immediately respond to protect the system and personnel from hazards. Non-critical and external system information is provided in the form of software permissives, and includes events from LTCS and operator acknowledgements.

See the [Laser Safety Subsystem](#) for more information on interfacing with the LSS.

6.7.4.2 Sky Alignment Camera

The Sky Alignment Camera exists primarily for system testing and laser alignment: this camera is not used during regular observing operations. The camera is physically located in the BGS, just after the beam expander, and can be used in either an up-stream (viewing asterism) or down-stream mode (viewing sky). To use the camera, a fold mirror is inserted into the beam path configured to pickoff the light from the lasers or to view the current pointing alignment of the telescope.

The Laser Sequencer Subsystem is responsible for initializing the sky alignment camera. Control and configuration of the device is performed through the observing tools.

7 Data Server

A block diagram of the data server is shown below in Figure 15. The server consists of a dedicated server-class CPU and RAID storage system and data recording and server tasks. The data recording hardware



interfaces to the server are not yet defined, but are expected to be similar to those of the existing AO system telemetry server, which uses a Fibre Channel interface for high speed data and GBit Ethernet for the moderate and slow speed data. The data recording task receives data from the recording interfaces and stores it directly into a database on the RAID storage system. The server task supports remote connections and near-real-time query capability of the database through the data server interface.

The data storage requirements for the system have not yet been defined, but are expected to include the following:

- High speed telemetry and diagnostics data from the real time controller
- WFS, acquisition, and truth sensor camera data
- TT sensor data
- System configuration and parameter data

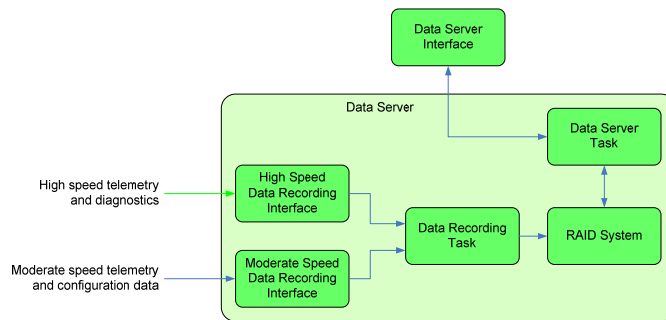

Figure 15: A block diagram of the data server architecture.

8 Risk Analysis

The largest risk to the non-real-time controls system design is the lack of specificity regarding the many devices to be controlled, both motion control devices and otherwise. In most cases we understand the type and number of devices to be controlled, but we do not know enough information to document the software and hardware interfaces required to control these devices. We also do not know how many controls device drivers (e.g., EPICS drivers) need to be written. As a result, all the work estimates must have a high level of risk assigned until more information is available and the design can be specified.

Another risk area is the very large number of degrees of freedom in the AO and Laser system motion control systems, approximately 200. During the PD phase, the controls design team should work very closely with the opto-mechanical team to simplify the design and only use the minimum number of controlled devices required.

The complexity of the LGS WFS and LOWFS assemblies and their motion control requirements are also a concern. The number of degrees of freedom is quite large, and the complexity of the coordinated moves required is also quite high. Again, the controls team should work very closely with the opto-mechanical team during the PD phase on these assemblies and their control requirements.

There is a vibration sensor included in the motion control spreadsheet. It is not clear who is responsible for the design of the vibration compensation control system (windshake compensation) or what the non-RT controls requirements are for this function. This needs to be addressed during the PD phase.



Finally, because there are so many unknowns with both the laser itself and the beam transport optics, it is difficult to define the required controls at this point. This gives the laser controls a high risk factor as well.

Comment [ktt6]: Needs to be updated!

9 Issues Requiring Resolution During DD Phase

The following items require urgent attention during the PD design phase.

- The overall data communications architecture for NGAO must be defined. We are currently assuming it is the observatory keyword system, but this must be decided.
- The motion control requirements (range, accuracy, bearing runout) need to be better defined for almost all of the devices to be controlled.
- The large number of degrees of freedom in the motion control system needs to be reduced.
- An overall motion control philosophy and architecture for the NGAO system must be developed.
- The numerous non-moving devices to be controlled must be better defined, along with the electronics required to control them.
- The high-level coordination sequences in the AO sequencer need to be defined.
- The device drivers required for device control (moving and non-moving) must be defined and scoped.
- The RTC command interface and high-level coordination sequences must be defined.
- The laser system high-level coordination sequences must be defined.
- The laser software interface must be defined (this is the software interface to the laser device delivered by the vendor).
- The laser motion control requirements need to be better defined.
- The acquisition, guiding, and pointing control interface needs to be better defined and scoped.
- The data storage requirements and data query requirements for the data server need to be determined.
- The requirements for the vibration compensation function need to be determined.



A1. Functional Requirements

Comment [ktt7]: Updated

ID	Short Name	Priority	PBS	Description	Verification Method
FR-456	Definition	Essential	3.3	<p>The overall controls system infrastructure is defined as all the infrastructure control functions that will be used throughout the AO Controls and LGS Controls system. Throughout the remainder of these requirements, the overall controls system infrastructure control functions will be referred to simply as "Controls Infrastructure". Controls Infrastructure shall provide the following basic functions for the AO and LGS Controls system:</p> <ol style="list-style-type: none"> 1. Device control for all controllable devices. 2. Motion control for all controllable opto-mechanical devices not directly concerned with the high speed measurement and correction of atmospherically distorted wavefronts. 3. Configuration and control of the RTC. 4. Support for system configuration, calibration and operations. 5. Monitoring the health of all subsystems and providing notification to other systems as required. 6. Control of the AO and Laser enclosure environment. 	Design
FR-1839	Health Monitoring	Essential	3.3	<p>Controls Infrastructure shall provide a health monitoring function that periodically checks all the AO and LGS subsystems for status. If an error is detected, Controls Infrastructure will provide notification to the other NGAO subsystems and users.</p>	Test



ID	Short Name	Priority	PBS	Description	Verification Method
FR-1840	Acquisition Control (move to FR-2220)	Essential	3.3	AO Controls will provide an automated acquisition capability to acquire all guide stars and science targets with limited operator oversight.	Test
FR-1841	Configuration Control	Essential	3.3	The Controls Infrastructure will provide an automated capability to configure the AO and LGS system for all modes of the system: startup, operational, calibration, and test. This includes configuring all the required cameras with the appropriate default parameters, configuring the appropriate devices on the optics bench, configuring the RTC, and configuring the AO related functions of the IFS (if necessary). The specifics of these configurations will be documented as use cases in the operations concept document.	Test
FR-474	Acquisition and Offload Control (move to science ops tools)	Essential	3.3	AO Controls will provide functionality to interact with the telescope control system (currently DCS) to implement control for: Acquisition (possibly an interface to MAGIQ or son-of-MAGIQ) Offload (tip-tilt, focus and coma offloading)	Test



ID	Short Name	Priority	PBS	Description	Verification Method
FR-1828	General Device Control	Essential	3.3	<p>Controls Infrastructure shall provide a control function for all non-motorized devices in the system capable of computer control. The devices to be controlled include: detectors, mirrors, the RTC, and the environmental system for the both AO and LGS enclosures. The control function shall provide, at a minimum, power control, device configuration and basic device control, unless these functions are not available.</p> <p>The motorized devices are addressed in a separate requirement on motion control.</p>	Test
FR-1834	Motion Control	Essential	3.3	<p>Controls Infrastructure shall provide a motion control function for all opto-mechanical devices requiring remote computer control. The control function shall include basic device control, configuration control, position control, tracking control for those devices that require it, and support coordinated moves of multiple devices.</p>	Test
FR-1832	Environmental Control	Essential	3.3	<p>Control Infrastructure shall provide a configuration control function for all the environmental control devices in the systems that require remote computer control.</p>	Test
FR-1812	Acquisition System data products	Important	3.3	<p>One hundred per night (TBC) acquisition images shall be stored on the NGAO data server. Images shall be in FITS file format and have standard FITS header information. The specific contents of the header are TBD. The data products from the acquisition system and the information from available catalogs or literature shall be recorded in the same photometry system and with</p>	Test



ID **Short Name** **Priority** **PBS** **Description** **Verification Method**

comparable spatial resolution.

FR-1913	Image Size and Profile Measurements (move to science ops tools?)	Important	3.3	The acquisition system shall include tools to measure the FWHM and ellipticity of images, and to provide a profile of these images.	Test
FR-3360	Logging	Important	3.3	The Controls Infrastructure shall provide logging of important system events, parameter changes, etc., to one or more log files.	Test
FR-3361	Alarms	Important	3.3	Controls Infrastructure shall provide an alarm system which allows both the reporting of and response to abnormal system conditions. It shall provide both automated and manual response options, multiple levels of alarm severity, a centralized alarm manager, and flexible alarm system GUIs which implement sorting capabilities.	Test
FR-3362	Data Recording	Important	3.3	The Controls Infrastructure systems shall support recording of parameter data, telemetry and diagnostics to the Data Server.	Test
FR-3363	Motion Control Tracking Rates	Important	3.3	Controls Infrastructure shall support minimum sustained input rates of 40 Hz for tracking motion control applications.	Test



ID	Short Name	Priority	PBS	Description	Verification Method
FR-3364	Data Types	Important	3.3	The Controls Infrastructure shall handle transmission of arbitrary data types, both scalars and arrays, with data sizes up to at least 1 Mb. The control system must support arbitrary data types, including structures. Many RTC parameters are arrays, which are also large in size. The maximum array size used by the RTC is estimated to be 1 Mb.	Test
FR-3121	Data Server	Unassigned	3.3.6	The NGAO Data Server is defined as the system that provides all the data recorder and server capabilities required by the NGAO system. This includes all database support, logging, archiving, general storage and retrieval. The data server must support all the data storage and retrieval requirements of the NGAO system.	Inspection
FR-3098	Data Server - Definition	Essential	3.3.6	The NGAO Data Server is defined as a computer in the network, with associated software, that is dedicated to the data storage and retrieval needs required by the AO Controls System. It holds the database management system, the databases and is part file server capable of housing non-database files such as FITS. In addition to providing data persistence, retrieval and data management there will be a telemetry data recorder, an ad-hoc data recorder, an alarm recorder, general logger, and configuration.	Design



ID	Short Name	Priority	PBS	Description	Verification Method
FR-3132	Data Storage Capacity	Important	3.3.6	At a minimum the Data Server shall store at least three month's worth of collected data [TBC] with a buffer of 1 month's worth. Once it reaches this limit, the oldest data of a configurable timeframe, i.e. 1 day, 1 week, 10 days, etc., will be automatically deleted.	Test
FR-3367	Data Recording	Important	3.3.6	All data recording will be performed through supplied APIs. It is expected that the underlying control system framework will provide services to support data persistence to the various data stores.	Test
FR-3368	Time Stamping	Important	3.3.6	All data stored in the data server should be time-stamped in a consistent manner. The recommendation is that UT is used for all time stamps. The timestamp should have at least a millisecond resolution or better. It is expected that the data server be clock synchronized with the rest of the AO Controls system.	Test
FR-3099	Support systems and services	Essential	3.3.6	The data server shall provide the database support for the following systems and services: a. The configurator b. The general logger c. The telemetry recorder d. The ad-hoc recorder e. The alarm recorder	Design



ID	Short Name	Priority	PBS	Description	Verification Method
FR-3369	Telemetry Recorder	Important	3.3.6	The Data Server shall provide a telemetry data recorder capable of recording time-stamped structured data. Grouped information will be stored and retrieved in an atomic and consistent manner. Ideally the telemetry recorder should not require the manual use or creation of meta data in order to function. The maximum burst and sustained rates for the telemetry recorder are TBD.	Test
FR-3370	Ad-hoc Recorder	Important	3.3.6	The Data Server shall provide the capability to record any requested set of published AO Controls System data at the fastest rate that the data is published for any specified amount of time. It is expected that data can be archived at a particular scan rate or based on some configurable event.	Test
FR-3371	General Logger	Important	3.3.6	The Data Server shall provide general AO Controls System logging. It will record all messages in a persistent store. The recording will include automatic timestamp and source identification. There should be separate categories for any message type. Logging should be capable of being enable/disable programmatically per component and should be capable of changing its logging level programmatically (log level can be used to mediate density).	Test
FR-3372	Alarm Recorder	Important	3.3.6	The Data Server shall have the capability to record all published alarm data. An alarm recorder will be available to record all generated alarms and alarm transitions. The recorder can	Test



ID	Short Name	Priority	PBS	Description	Verification Method
FR-3373	Configurator	Important	3.3.6	be enabled and disabled as appropriate. The Data Server shall provide for the storage and retrieval of system configuration information. Calibration data should be made available for an indefinite period	Test
FR-3374	Auto Recovery	Important	3.3.6	The Data Server shall auto recover from disk failures so an observing nights data is not lost. This could be through the use of a RAID system, disk duplication, etc...	Test
FR-3375	Scalable Data Storage	Important	3.3.6	The data store shall be capable of scaling to increase the amount of data storage as needed.	Test
FR-3376	Permanent Archival Storage of Data	Important	3.3.6	The data server shall support permanent archival storage of both raw and processed data. A permanent archive shall include removable media. The archival mechanism must be able to write to a removable media (tapes, hot-swap disks, or a future transportable media) and possibly HQ through its network interface.	Test
FR-3377	Extract and Save	Important	3.3.6	The data server shall have the ability to save off portions of a database to external files for later processing.	Test
FR-3103	Simultaneous queries	Essential	3.3.6	The data server shall support simultaneous high-speed storage and recall (queries).	Test
FR-3107	Error handling	Essential	3.3.6	The Data Server shall provide error logging, alerts, and messages. It should also make its alarm visible to an operator during operations.	Test



ID	Short Name	Priority	PBS	Description	Verification Method
FR-3109	Reliability	Essential	3.3.6	The Data Server shall have a MTBF of 10hrs (TBC) or a minimum of a full observing night. An unfortunate loss of the Data Server should not prevent the AO Controls System from continuing to run.	Design
FR-1842	Calibration Control	Essential	3.1	AO Controls will provide a semi-automated capability to calibrate the AO system, to include computation of DM actuator gains, DM to WFS registrations, centroid gains, interaction matrices, WFS calibrations, etc. The term semi-automated is used here to indicate that the calibration capability shall minimize the amount of user interaction required.	Test
FR-470	Sensor Calibration Measurements	Essential	3.1	AO controls will provide an automated capability to compute the dark frames, sky frames, and flat fields for all the various sensors in the AO system as required.	Test
FR-1843	Telemetry	Essential	3.1	AO Controls shall provide appropriate telemetry streams for the other AO subsystems, instruments, telescope control system, and top-level MCS, as required. The list of telemetry streams required by these systems is currently unknown; as they become defined, individual requirements will be written for each stream to be generated.	Test
FR-479	Atmospheric Profiler	Essential	3.1	AO Controls shall publish atmospheric turbulence profile (Cn2) information from the atmospheric profiler.	Test



ID	Short Name	Priority	PBS	Description	Verification Method
FR-1829	Detector Control	Essential	3.1	AO Controls shall provide a configuration control function for all the detectors in the system. In addition to the basic device control functions, the detector control shall include the setting of exposure times and frame rates, bias fields and flat fields, filter and gain settings, and shutter control, if applicable.	Test
FR-1831	RTC Control	Essential	3.1	AO Controls shall provide a configuration control function for the RTC. In addition to the basic control functions, the RTC control function shall include the setting/readback of all RTC parameters, such as reconstructor arrays, centroid offsets, centroid gains, loop gains, etc., and loop control for all the AO correction loops in the system, includes both go-to and feedback loops.	Test
FR-467	Altitude tracking	Important	3.1	AO controls must provide altitude tracking for the LGS WFS (in LGS mode).	Demonstration
FR-461	Truth Wavefront Sensor	Important	3.1	AO Controls is responsible for control of the TWFS and calculating low-order WFS focus correction for the RTC.	Demonstration
FR-3188	Field Rotation Offload	Important	3.1	The AO Controls shall compute the field rotation error from the average tip-tilt signal of the NGS low order wavefront sensors as output from the RTC telemetry. The field rotation error should be computed at a rate of 10 Hz (TBC). The AO Controls system will use this information along with Telescope position information to update the position of the AO field derotator. Offload data from the RTC includes the separate average tip/tilts from each NGS LOWFS channel.	Test



ID	Short Name	Priority	PBS	Description	Verification Method
FR-3365	Loss of Communications	Important	3.1	In the event AO Controls fails to establish communication or loses communication with any controller or service, other than a safety system, it shall generate an appropriate alarm and attempt to continue operations to the best of its ability or enter a safe state depending on the condition. The operator, upon receiving the alarm, will be able to take action as needed.	Test
FR-2483	Overall	Unassigned	3.2	This folder contains overall requirements that span multiple engineering disciplines	N/A
FR-2130	Definition	Essential	3.2	The LGS control system is defined as all the LGS control functions that are not directly concerned with the high speed measurement and correction of atmospherically distorted wavefronts. Throughout the remainder of these requirements, the LGS control functions will be referred to simply as "LGS Controls".	Design



ID	Short Name	Priority	PBS	Description	Verification Method
FR-2131	Basic Functionality	Essential	3.2	<p>LGS Controls shall provide the following basic functions for the LGS facility:</p> <ol style="list-style-type: none"> 1. A control system, supporting: <ul style="list-style-type: none"> Simple and complex commands Synchronous and asynchronous commands Command completion monitoring Error detection, handling, notification and recovery User interfaces supporting graphical, command line, and script modes 2. Device control for all controllable devices in the LGS facility. 3. Motion control for all controllable opto-mechanical devices in the LGS facility. 4. Configuration and control of the laser system. 5. Support for LGS facility configuration, calibration and operations. 6. Logging of all telemetry data to the data server. 7. Monitoring the health of all LGS facility subsystems and providing notification to other systems as required. 8. Control of the Laser enclosure environment. 9. Interfaces to the other NGAO and observatory subsystems: <ul style="list-style-type: none"> AO System LTCS Telescope Control System Data Server Multi-System Command Sequencer 	Test



ID	Short Name	Priority	PBS	Description	Verification Method
FR-2143	General Device Control	Essential	3.2	<p>LGS Controls shall provide a control function for all non-motorized devices in the LGS facility capable of computer control. The devices to be controlled include: detectors, mirrors, and the environmental system for the Laser enclosure. The control function shall provide, at a minimum, power control, device configuration and basic device control (initialize, standby, start, stop, power up/down, read status, etc.), unless these functions are not available.</p> <p>The motorized devices are addressed in a separate requirement on motion control.</p>	Test
FR-2144	Detector Control	Essential	3.2	<p>LGS Controls shall provide a configuration control function for all the LGS facility detectors. In addition to the basic device control functions, the detector control shall include the setting of exposure times and frame rates, bias fields and flat fields, filter and gain settings, and shutter control, if applicable.</p>	Test
FR-2146	Laser System Control	Essential	3.2	<p>LGS Controls shall provide a configuration control function for the laser system. In addition to the basic control functions (initialize, standby, start, stop, etc.), the laser control function shall include the setting/readback of all laser parameters.</p>	Test
FR-2147	Environmental Control	Essential	3.2	<p>LGS Controls shall provide a configuration control function for all the environmental control devices in the laser enclosure that require remote computer control.</p>	Test



ID	Short Name	Priority	PBS	Description	Verification Method
FR-2149	Motion Control	Essential	3.2	<p>LGS Controls shall provide a motion control function for all opto-mechanical devices in the LGS facility requiring remote computer control. The control function shall include basic device control (initialize, standby, start, stop, etc.), configuration control, position control, tracking control for those devices that require it, and support coordinated moves of multiple devices. As of this writing, the opto-mechanical devices requiring motion control are as follows (number of degrees of freedom shown in parentheses):</p> <ul style="list-style-type: none"> Laser Shutter (1 DOF) Polarization waveplates (3 DOF) BTO bottom mirrors (4 DOF) BTO mid mirrors (4 DOF) BTO top mirrors (4 DOF) Shutter (1 DOF) Point and shoot beam splitter (2 DOF) Star imager pickoff (1 DOF) Point and shoot steering (6 DOF) Asterism rotator (1 DOF) Asterism tip/tilt (2 DOF) Fast shutter (1 DOF) Beam expander focus (1 DOF) LTO cover (1 DOF) LTO polarization sensor (1 DOF) LTO focus lens (1 DOF) <p>As more information is known about the motion control needs for these devices and subassemblies, individual requirements will be added to address them.</p>	Test



ID	Short Name	Priority	PBS	Description	Verification Method
FR-2150	Motion control coordination	Essential	3.2	LGS controls will coordinate the LGS facility motion control and other tasks needed to perform dithering, offsetting and chopping for science observations.	Test
FR-3366	Loss of Communications	Important	3.2	In the event LGS Controls fails to establish communication or losses communication with any controller or service, other than a safety system, it shall generate an appropriate alarm and attempt to continue operations to the best of its ability or enter a safe state depending on the condition. The operator, upon receiving the alarm, will be able to take action as needed.	Test
FR-2484	Optical	Unassigned	3.2	This folder contains optical requirements	N/A



ID	Short Name	Priority	PBS	Description	Verification Method
FR-2132	Command Processor	Essential	3.2	<p>LGS Controls shall provide a command processor (sequencer) with the following functionality:</p> <ol style="list-style-type: none"> 1. Processing of simple commands. An example of a simple command is the setting of a single parameter. 2. Processing of complex commands. An example of a complex command is to configure the LGS facility for a particular mode of operation. This will require setting several parameters, configuring any optical devices, and checking for valid completions of all. 3. Processing of synchronous commands. A synchronous command is one where the latency of the task to be performed by the command is negligible. 4. Processing of asynchronous commands. An asynchronous command is one where the latency of the task to be performed is large enough to require spawning a thread to execute the task and monitor for a command completion callback. 5. The return status of every command (or sub-command in the case of complex commands) must be checked for valid completion or error. If an error occurs, appropriate actions must be taken to process the error, abort the command or task if required, notify the requestor of the error, and take action to recover from the error, protecting the LGS facility as required. 6. A command interface that supports graphical, command-line, and script modes. 	Test



ID	Short Name	Priority	PBS	Description	Verification Method
FR-2133	Health Monitoring	Essential	3.2	LGS Controls shall provide a health monitoring function that periodically checks all the LGS facility subsystems for status. If an error is detected, LGS Controls will take appropriate actions to protect the LGS facility and provide notification to the other NGAO subsystems and users.	Test
FR-2135	Configuration Control	Essential	3.2	LGS Controls will provide an automated capability to configure the LGS facility for all modes of the system: startup, operational, calibration, and test. This includes configuring all the required cameras or sensors with the appropriate default parameters and configuring any optical devices as required. The specifics of these configurations will be documented as use cases in the operations concept document.	Test
FR-2136	Calibration Control	Essential	3.2	LGS Controls will provide a semi-automated capability to calibrate the LGS facility, to include alignment of all movable LGS optical devices. The term semi-automated is used here to indicate that the calibration capability shall minimize the amount of user interaction required.	Test
FR-2138	Telemetry	Essential	3.2	LGS Controls shall provide appropriate telemetry streams for the other AO subsystems, instruments, telescope control system, and top-level MCS, as required. The list of telemetry streams required by these systems is currently unknown; as they become defined, individual requirements will be written for each stream to be generated.	Test



ID	Short Name	Priority	PBS	Description	Verification Method
FR-2141	Copy of Interface to LTCS	Essential	3.2	LGS controls will respond appropriately to protect the LGS facility and recover gracefully from a laser traffic control event.	Test